



ZIVA

— THE WAY TO LIVE —

24
ZIVA

GLOBAL EDITION

ZIVA

Our aspiration is to create a suite of products, content, and digital solutions that travel beyond functionality to inspiration, equipping athletes and enthusiasts with the means to achieve greatness.

CONTENTS

INTRODUCTION

Prologue	04
ZIVA Ecosystem	06
ZIVA Tao Digital Solutions	08
ZIVA Professional Education	18
Partners and Key Accounts	20

INFINITY X

ZIVA Tao	26
Modular Wall System	28
Training Tower	30
Corner	32
Accessories	34

STRENGTH

ZVO Free Weights	46
EX Dumbbell Racks	54
SL Free Weights	62
XP Free Weights	70
ST2 Dumbbell Racks	72
ZVO Olympic Bars	76
ZVO Tribells	82
EX Power Racks and Platforms	84
XP Power Racks	88
EX Benches	92

PERFORMANCE

EX Training Stations	110
XP Modular Training Station	114
XP Storage	116
Signature Battle Rope and PowerWave	122
VIPR by ZIVA	128
SL Tyre X	132
ZVO Anti-burst Core-fit Balls	134
Plyo Boxes	136
ZVO and XP Bumper Discs	140
ZVO Olympic Bars	144
XP Olympic Platform	146
ST2 Hexagon Dumbbell Racks	148
Hexagon Dumbbell Racks	149
SL Hexagon Dumbbells	150
XP Hex Dumbbell Racks	152
XP Hex Dumbbells	153
Signature Kettlebells	156
Kettlebells and Racks	160
ZVO Slam Balls	166
ZVO Medicine Balls	167
ZVO Wall Balls	168
ZVO Power Core Bag	169
XP and ST Ball Storage Racks	170
XP Modular Rigs	176
XP Accessories	184

GROUP X

Signature FitBench	194
Signature Powerwave	196
VIPR by ZIVA	198
PRO FT Step	199
ST Studio Barbell Rack	200
Yoga Mats	202

CUSTOMIZATION

ZVO Free Weights	206
XP Rigs	216

GLOBAL OFFICES	220
----------------	-----

WARRANTY	222
----------	-----



PROLOGUE

REFINING AND REDEFINING AN INDUSTRY

Founded in 2008, **ZIVA** is the global innovative fitness brand rooted in the ancient Taoist philosophy of energy and balance.

Standout, inspirational design and precision-made, high quality manufacturing has been at the heart of **ZIVA** from the beginning.

Our mission is to create functional products and digital solutions that not only achieve what they are designed to but also that inspire and engender real pride, providing athletes and enthusiasts alike with a transformational platform designed to achieve their goals.

Innovation is a driving force at **ZIVA**, as we have learned to harness the power of change to constantly improve and offer always new products and solutions to our partners around the world.

As a result, every day in over 80 countries thousands of people train with **ZIVA** products around the globe. To be an active part of this collective effort toward self-improvement and positive transformation is what really drives our commitment and teamwork through our network of partners, distributors and international offices.

ZIVA, The Way to Live

ZIVA trademarks are owned by ZIVA Company Limited and its affiliates.
The entire contents of this catalog are copyrighted by ZIVA Company Limited and its affiliates.

OLYMPICS TOKYO 2020

BRAZILIAN OLYMPIC COMMITTEE PARTNER

ZIVA is proud to be the official partner of the Brazilian Olympic Committee in Brazil.

In 2015 **ZIVA** designed and installed **ZIVA** Olympic High Performance Athletes Lab at the Maria Lenk Center in Rio de Janeiro. The center is continually updated to feature our newest series of strength and performance products for all Olympians to train on now and for years to come. We are honored to contribute to the training center to help Brazilian Olympians push beyond their boundaries and create the next generation of champions.

Together we are looking forward for Tokyo 2020 where **ZIVA** will be creating performance training centers in Tokyo to support the athletes and power their medal dreams.



“*COB is proud to have ZIVA, which is a reference in the fitness and sports segment, as a partner in preparing Team Brazil for the Tokyo Olympics. Since 2015, our athletes have best quality equipment available for strength training and conditioning.*”

Jorge Bichara
Sports Director
Brazil Olympic Committee



ZIVA ECOSYSTEM

The ZIVA ECOSYSTEM is comprised of four pillars that work together to bring to the global fitness and wellness markets best in class products and solutions powered by world class design, content and education delivered on our digital platforms.

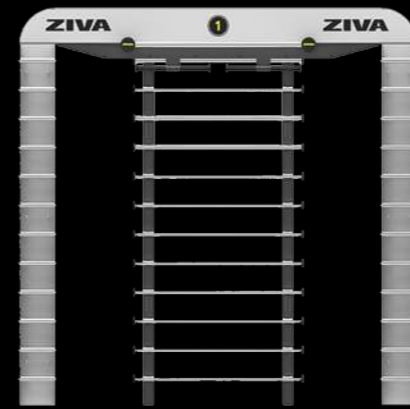
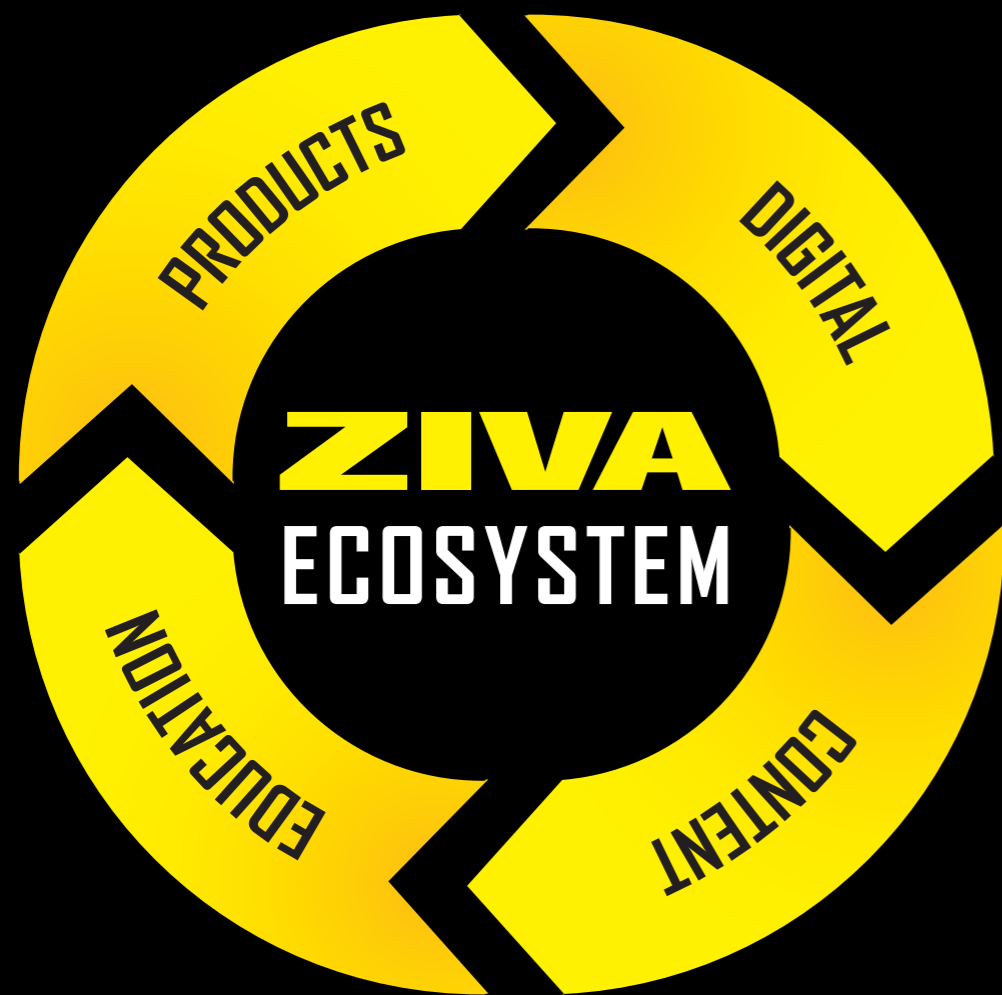

PRODUCTS

- Extensive commercial and home products series
- Best in class designs
- Industry leading quality
- Precision manufacturing
- Italy design center
- China and Italy manufacturing and R&D facilities



DIGITAL

- Tao software - Manage and Train
- ZIVA FITNESS NATION - Global fitness community
- Solutions for studio, wellness and fitness clubs
- Interactive touch stations
- POS digital shop system for clubs and retailers
- German - based software development team



EDUCATION

- Online education courses and exercise tutorials
- Live international courses
- Certified courses with CECs
- Strategic partnerships with product inventors
- Full sized workout guidance cards with QR linked demos
- Global collaboration of fitness educators and presenters

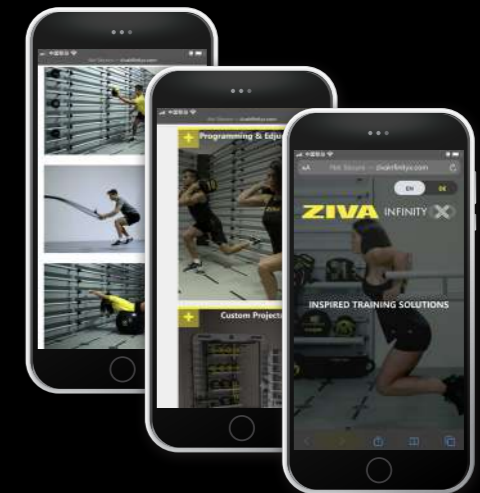

CONTENT

- Extensive multi-language exercise library
- Professional workout templates
- Individual product line videos and programs
- Social media support
- Website and apps
- USA - based Los Angeles live studio

TAO SOFTWARE

ZIVA's new powerful digital solutions
for fitness and wellness clubs

INTRODUCING
TAO MANAGE and TAO TRAIN

DIGITAL SOLUTIONS FOR STUDIOS, FITNESS AND WELLNESS CLUBS

- High profitability and productivity boost
- Continuous further development and community growth
- Own cloud based management platform
- Cutting-edge marketing solutions
- Member recruitment and member retention
- Reach your customers and prospective customers through multiple channels
- Upselling and cross-selling
- Fully networked training space



INSPIRE MEMBERS WITH DIGITAL SOLUTIONS REACH – ENTERTAIN – RETAIN MEMBERS

With your own studio community app, website and display network, which is controlled via an in-house content management system, the marketing and entertainment possibilities are limitless.

- Studio community
- Studio shop
- Multimedia news system
- Interactive auto push messages
- Members feedback and support management
- Loyalty program

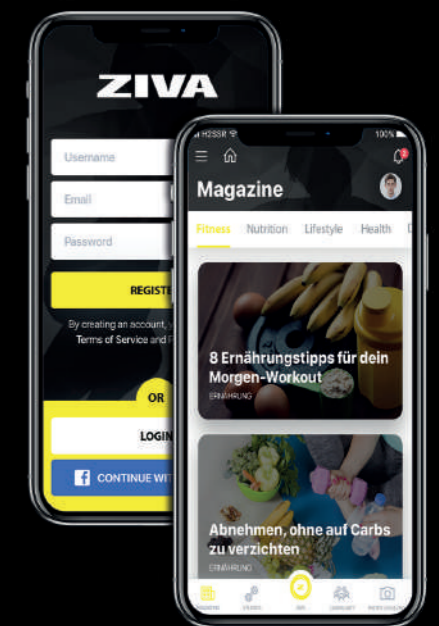



Ihr Studio • 9:45
 A big welcome!
 We wish you a good workout!

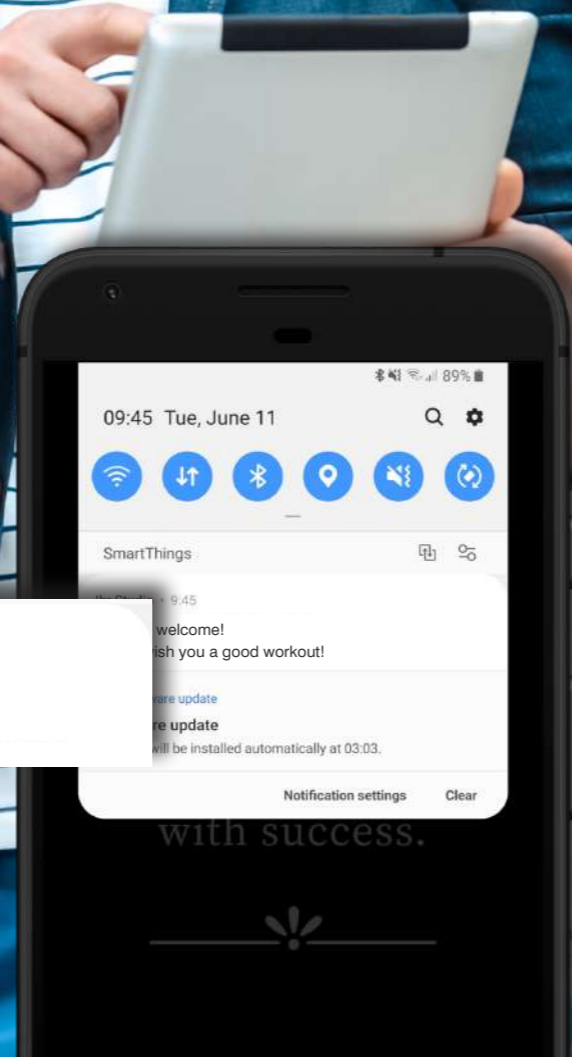

TAO MANAGE

- 

Member management
- 

Profiles of specialists
- 

Push notifications
- 

Course management
- 

Digital check-in by beacon and QR code
- 

Booking management
- 

Membership
- 

Appointment management
- 

Access management
- 

Banking
- 

Team management and work plans
- 

Online course booking

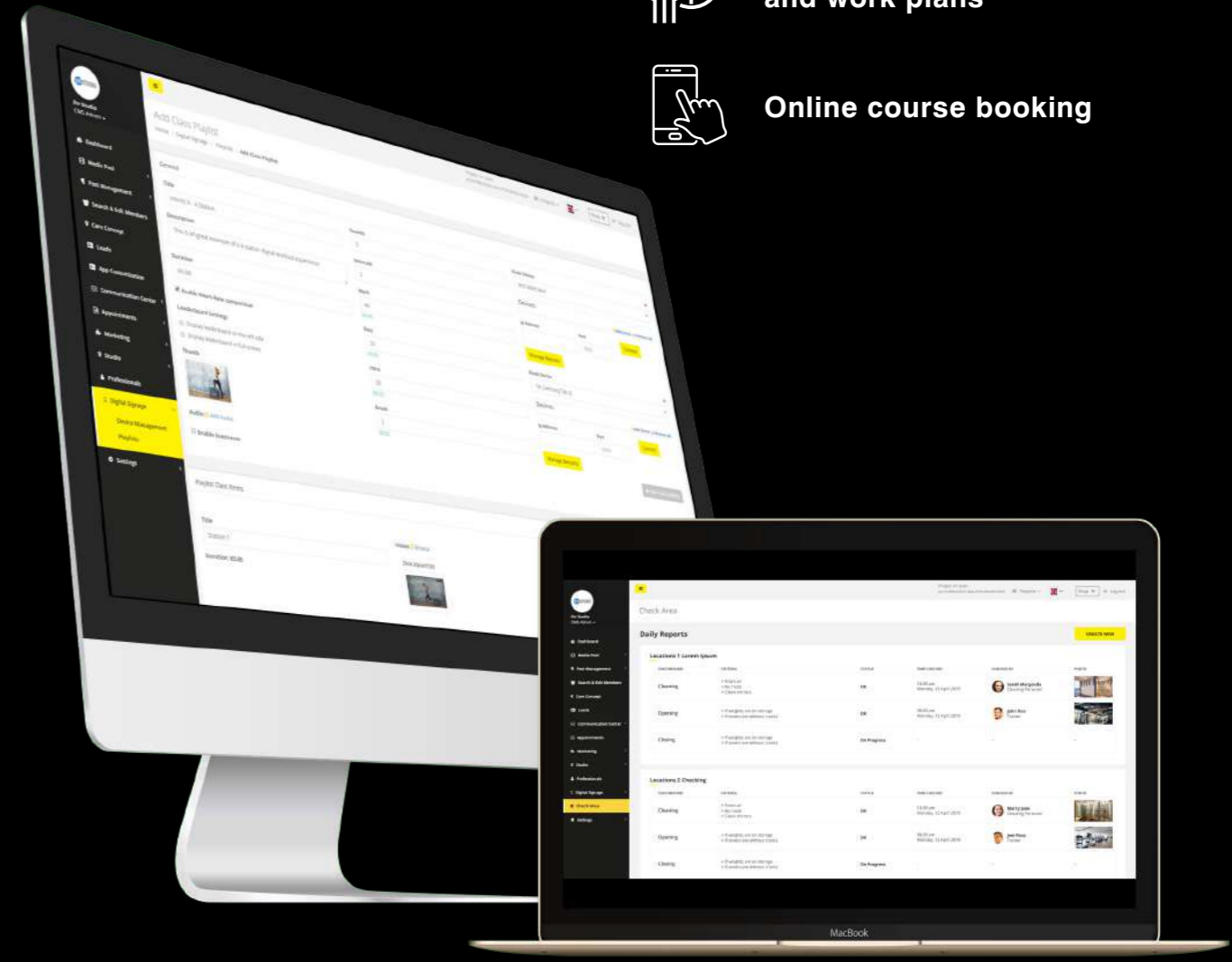

TAO TRAIN



Health check



Workout generator

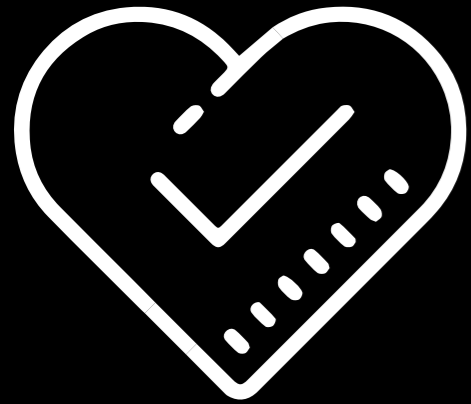

Group course generator



Workout of the day (WOD)



Exercise Video Library
X Team Training



Live content

TRAINER PAD

- Member management
- Training management
- Health check
- Schedule agreement
- Course management
- Intuitive user interface



Our automated support helps fitness studio employees with the evaluation of various types of information on the health and fitness status of the members and facilitates the creation of individual training plans.

TAO SOFTWARE FEATURES

STUDIO COMMUNITY APP BRANDED MOBILE APP (IOS AND ANDROID)

Features

- Information about your studio
- News and offers
- Course planning
- Studio community
- Training partner search
- Workout of the day
- Fitness challenges
- Your own online shop
- Individual training plans

Advantages

Your studio gets its own attractive Android/iOS app, which you can use to stay in touch with your members and keep them informed about all vital current topics. Build your own fitness community around your studio.

Become part of ZIVA TAO fitness & lifestyle community. Recruit new members and strengthen your own studio community. Experience fitness and entertainment at the highest level. Gain access to our premium studio features and boost loyalty of your members.

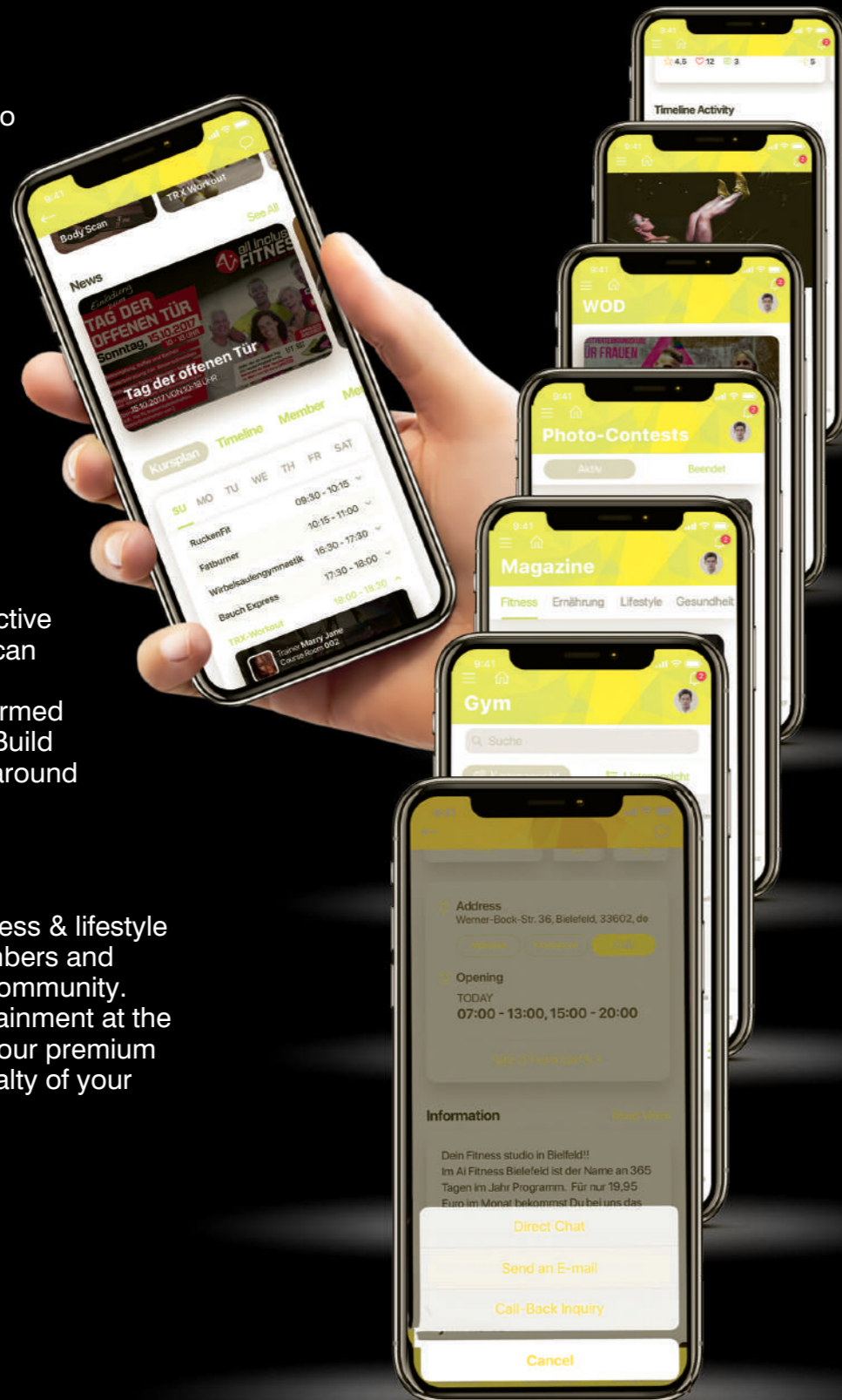

INTERACTIVE TOUCH SOLUTIONS

State-of-the-art touch info terminals in various sizes with many useful features for the studio environment – individually customised for your studio.

Features

INFORMATION

Increase the interaction of your members. Provide them with additional information and save your own resources.

ADVERTISING

By combining information, features and advertising screens, you have an excellent tool for customer-focused advertising.

ORGANISATION

Save time in your studio routine, since various processes, such as answering customer questions and booking courses, can be automated.

ENTERTAINMENT

Exercise library, training schedule and group playlists are great entertainment tools for you to entertain your members.

CUSTOMISE

Easy customisation of the user interface as well as the look and feel of the kiosk screen – with just a few clicks, from anywhere.

STANDARD MENU

Current courses, info point (description, services, news), course plan.

ACTIVATABLE FEATURES

Kiosk customisation, shop, trainer call, team introduction, online membership, trial training session, exercise library, workout generator, guest book, action buttons, group courses, heart rate challenges, newsletter, studio rating.

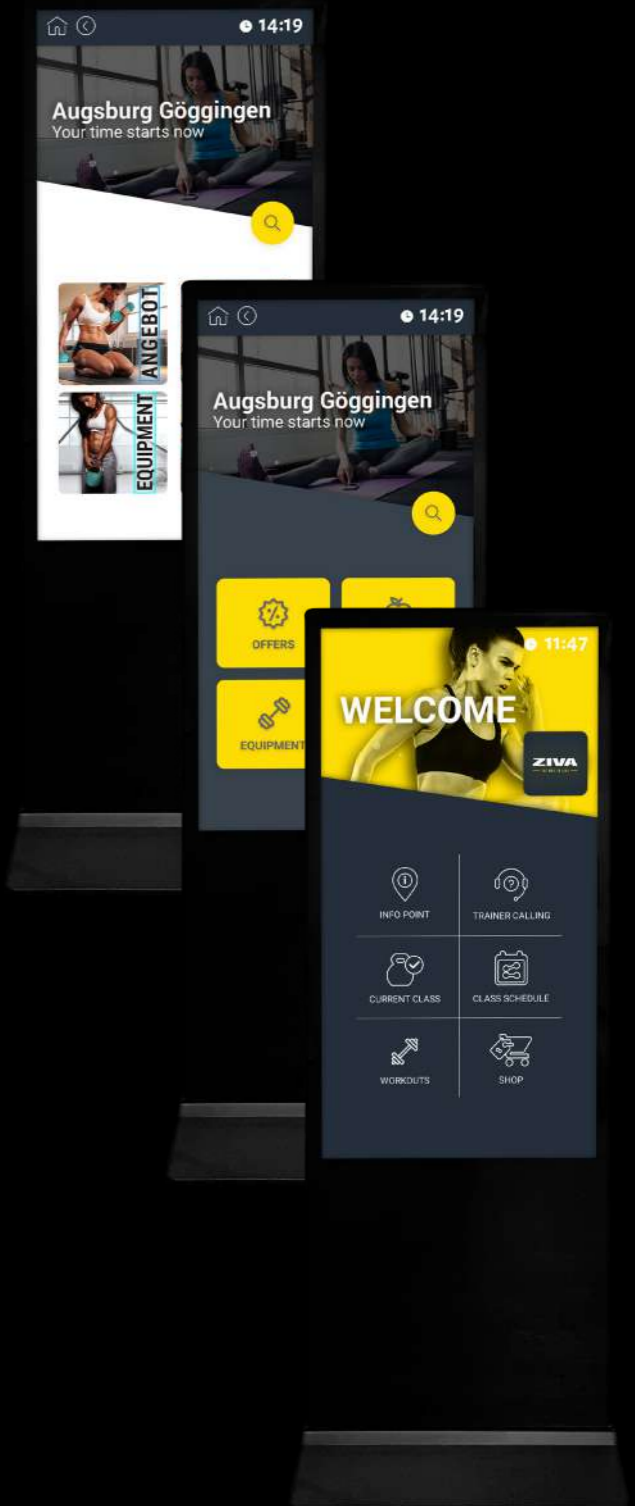

Advantages

Manage your content on all devices via a digital signage network. Different app menus can be configured for different kiosk devices.

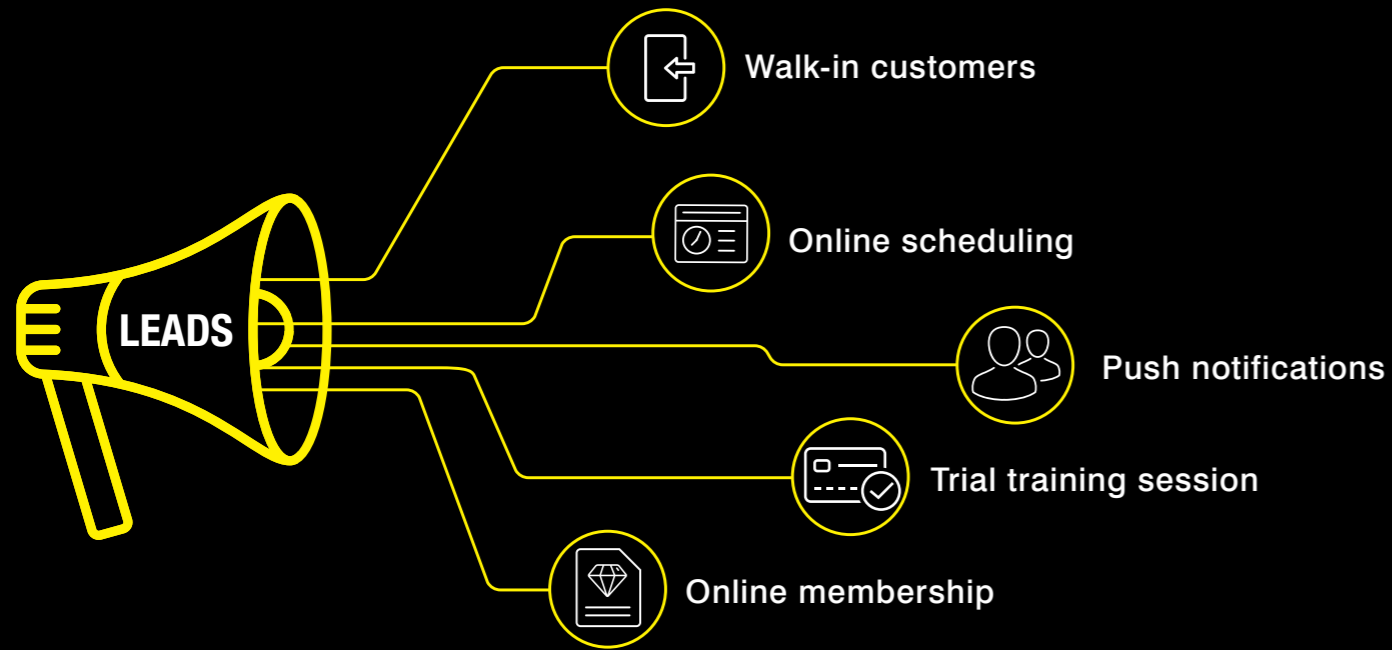

MARKETING

Lead Generation

Gain access to a variety of lead-generating features and recruit new members automatically through online marketing.

Push Notifications

Use push notifications as quick and easy communication channel with members and sent auto generated Push Notifications for appointments and advertising.

Trial Training Session

Manage requests for trial training sessions and give potential members the opportunity to see for themselves the many advantages of your studio.

Schedule Management

Manage scheduling inquiries generated online via our predefined topic-specific landing pages and confirm and monitor the inquiries with the help of the schedule management.

Online Memberships

Anytime, anywhere. Both the individual landing pages and the kiosk systems in the studio can achieve fantastic success in the acquisition of memberships. Prospective customers can easily and independently fill out membership forms.

Analyses

Get quick access to main important Analytics and an overview of your members.

Landingpage

Create your own branded Landingpage with our integrated Landingpage generator. Easy to use and very useful to attract members.

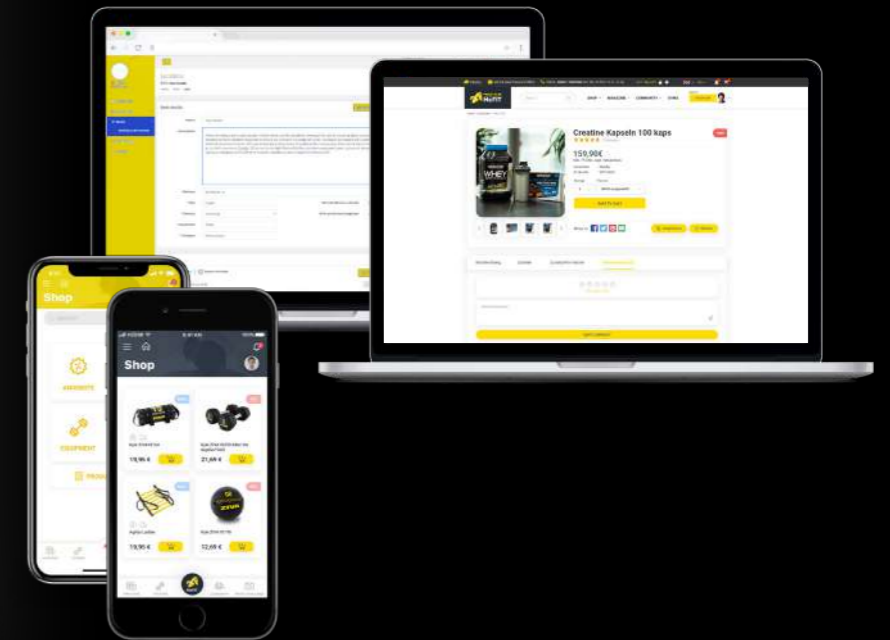
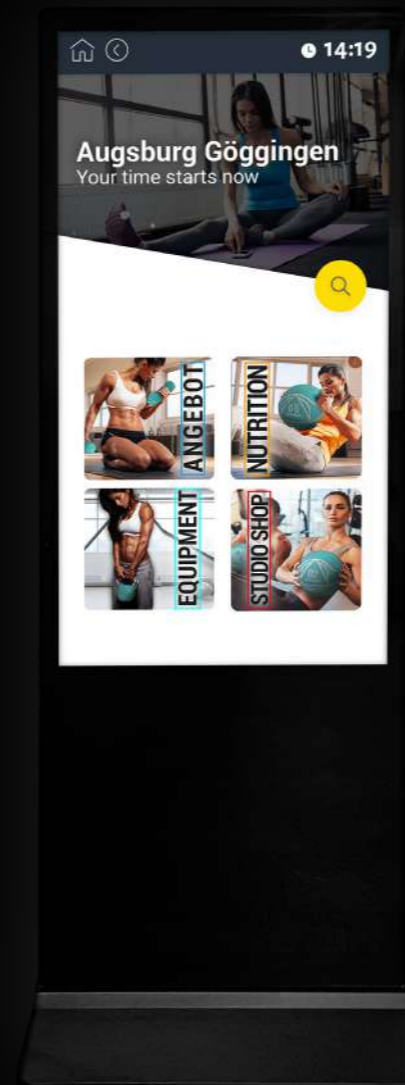

SHOP SYSTEM

Offer your members a fitness shop with selected offers and your own merchandise products.

A fully integrated bonus system boosts member retention and sales. We take care of the operation of the shop – you profit from the turnover.

CUSTOMER JOURNEY

Integration of the customised shop system in:

- Studio community app
- Kiosk systems
- Counter tablet
- Global fitness shop
- Studio's own merchandise shop
- Bonus program for fitness studios
- Loyalty program for members



ZIVA PROFESSIONAL EDUCATION

ZIVA's aim is to build not just a fitness business, but a legacy of fitness which impacts the future vitality of the industry we love so much; that's why we invest into our clients and customers with high quality HOME exercise instruction for retail users and PROFESSIONAL education content and programs for the fitness professionals utilizing our equipment in commercial settings to improve the lives of those they train every day.

Never haphazard in care or execution, ZIVA education is the product of a worldwide collaboration of top level trainers, innovators, and competitors. Curated by ZIVA's Director of Education, 20-year multi- and master-certified trainer and trainer educator Jason McClure, our fitness education content is developed and professionally produced across four continents. Featuring ZIVA professional trainers, ambassadors, and presenters, we've worked hard to ensure that our educational resources are not an afterthought.



ZIVA EXERCISE LIBRARY

This yellow icon identifies home and commercial products featured in the ZIVA exercise library. The ZIVA Exercise Library is an online database of exercise demos and tutorials built around ZIVA kit to inspire fresh approaches to exercise while mitigating unnecessary risk and injury.



ZIVA EXERCISE PROGRAMMING

The gray ZEP icon marks home and commercial products featured in programmed exercise templates built to guide enthusiasts and trainers through sample workouts and routines. ZIVA Exercise Programming content may be presented in printed or video formats.



ZIVA PROFESSIONAL EDUCATION

The black ZPE icon indicates a commercial product with accompanying complimentary and/or paid professional level education. All professional education content is created specifically for exercise professionals, and is created and presented by a recognized authority in fitness education. ZPE content ranges from advanced tutorials to complete online certifications.



Worldwide kettlebell authority and ZIVA Ambassador Steve Cotter



Team ZIVA presenters Ashley and Trey



Team ZIVA presenters Corey and Taylor

GLOBAL KEY ACCOUNTS

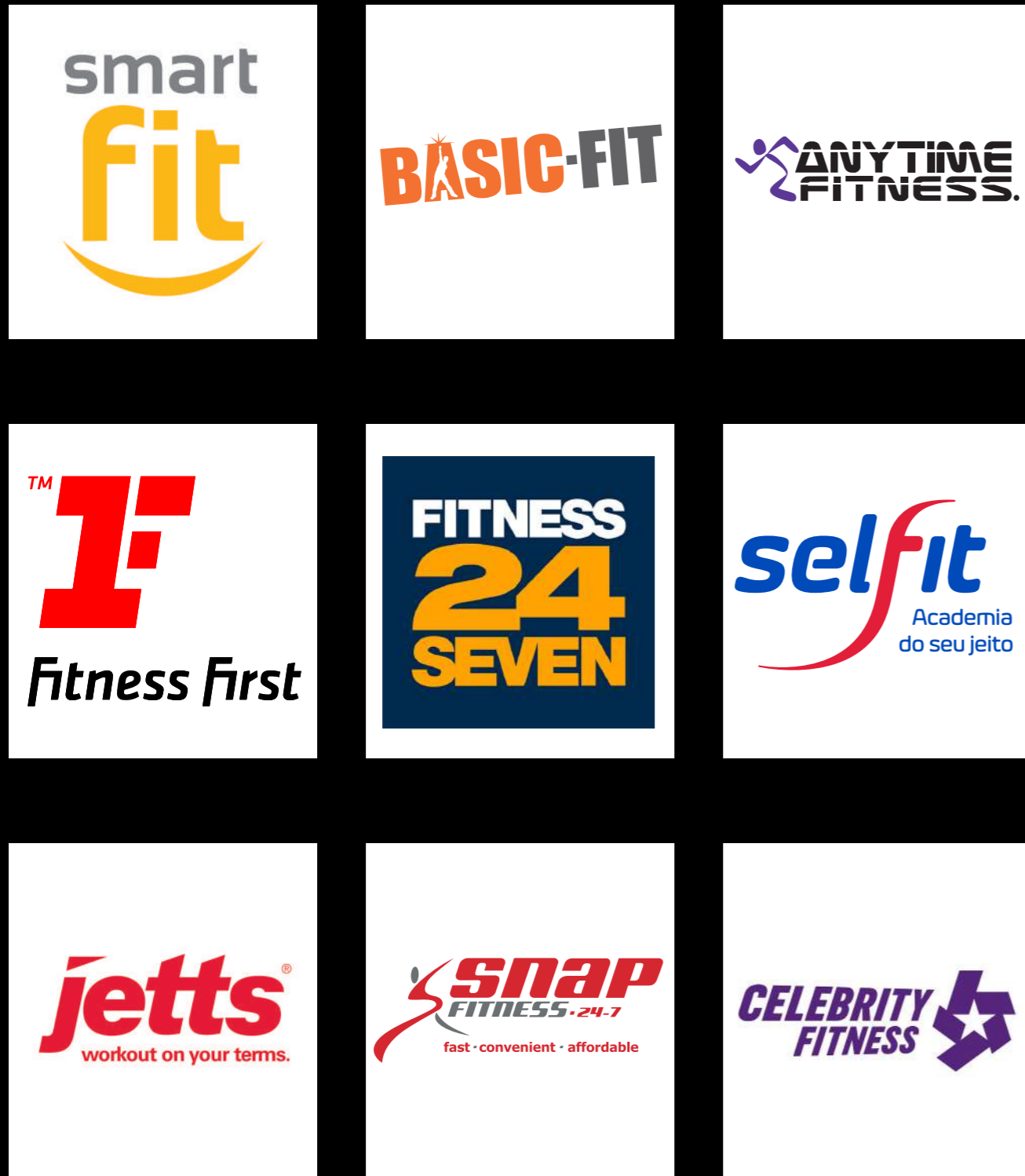

GLOBAL CUSTOMERS

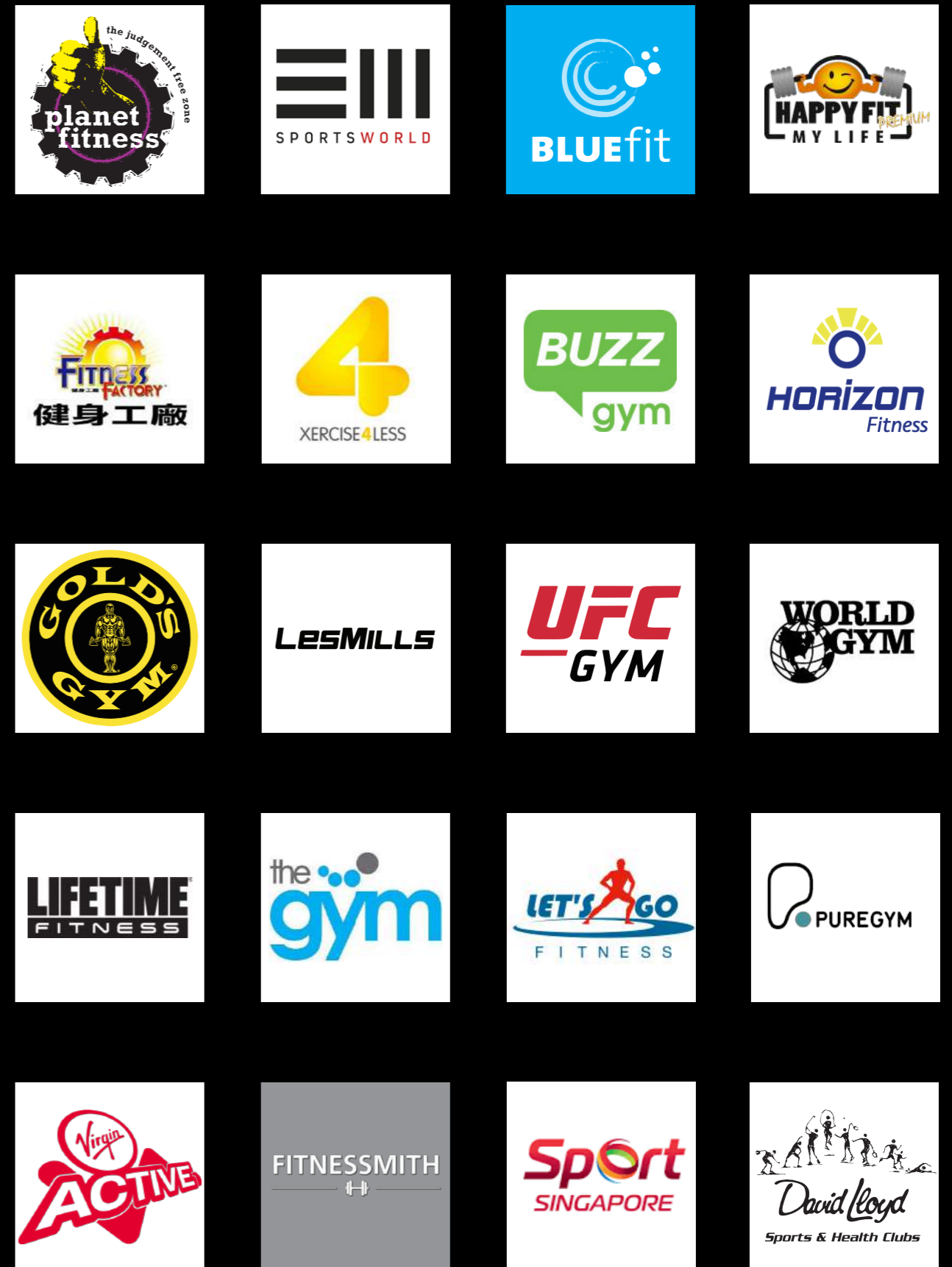

INFINITY X

Functional training stations the way you've never seen them before. Sleek designs and colorways with multiple configurations to accommodate any training space. Versatile integrated storage and training attachments with a myriad of exercise options. Endless opportunities to attain your best.





BOXING
- LEGENDARY -

ZIVA
BOXING
- LEGENDARY -

ZIVA

ZIVA

ZIVA

INFINITY X POWERED BY TAO SOFTWARE

We have redefined the course experience and team training. Offer your members an incredible training experience through the automated interaction of all necessary components.

Features

- Exercise library with over 250 videos
- Workout of the day
- Workout generator with training templates
- Reservation and booking tool for courses and stations
- Trainer call
- Course plan and team introduction
- Your own mobile app for members with individual training plan
- Motivation through fitness point system
- Heart rate monitoring

Group course and team training course generator

- Interval timer
- Digital workout display
- Automatic countdown by light, sound and video
- Video exercise tutorials
- Music players and motivating sound files
- Light show
- Online training area for trainers with District80 program

Key Features:

- Creation of training plan templates
- Individual training plans
- Send automatic reminders to customise training plans
- Access to the training history
- Print the training plan or send it to the member's e-mail address

MODULAR WALL SYSTEM 125



Order Code

ZFS-XWMT-6991
ZFS-XWMT-6992
ZFS-XWMT-6993
ZFS-XWMT-6997

Item Description

3 Pcs. Infinity X Modular Wall System
4 Pcs. Infinity X Modular Wall System
5 Pcs. Infinity X Modular Wall System
7 Pcs. Infinity X Modular Wall System

Color Options:

Black or Silver

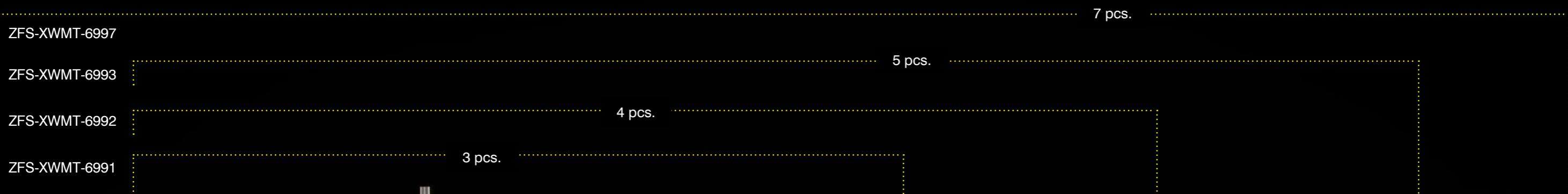

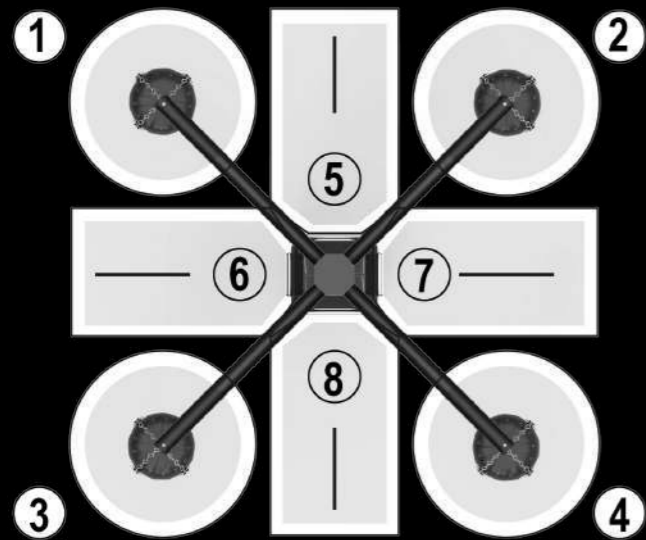

One tower unit, 3.5m², 8 users
Maximum flexibility for PT in a small area



TRAINING TOWER

Order Code
ZFS-XTTR-6721



TRAINING TOWER WITH 4 BOXING BAG SUPPORTS

Order Code
ZFS-XTTR-6776

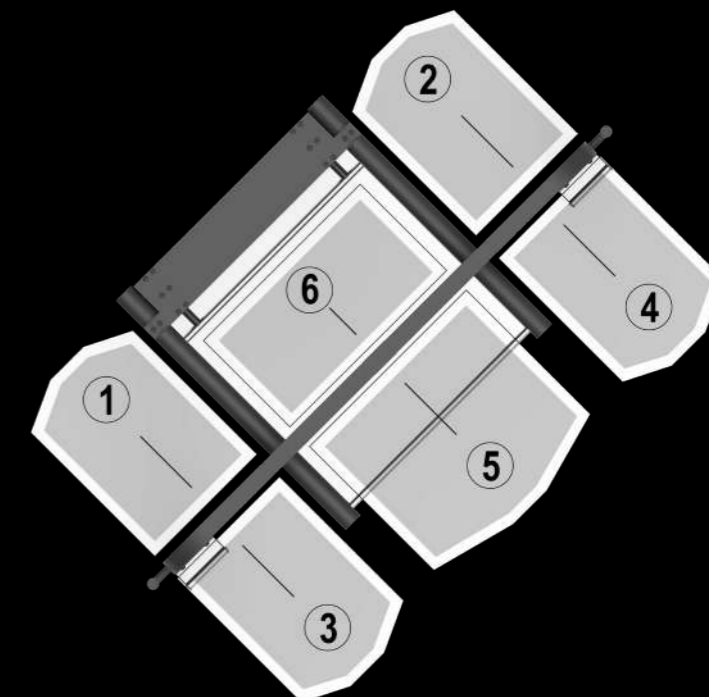

One corner unit, 3.5m², 6 users
Maximum flexibility for PT in a small area



CORNER

Order Code

ZFS-XCRN-6720

MINI GYM WALL BAR

Order Code

ZFS-XGWB-6750

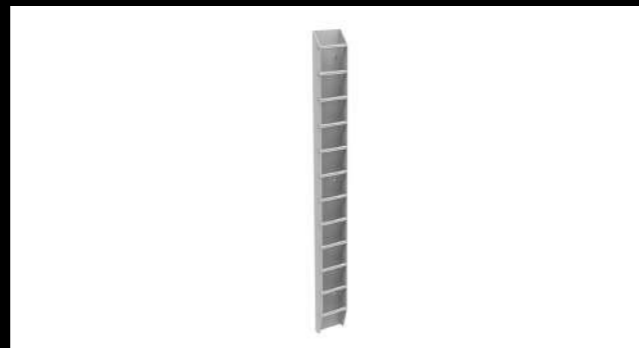

BOXING BAG SUPPORT

Order Code

ZFS-XBDO-6708



BALL TARGET

Order Code

ZFS-XBDO-6707

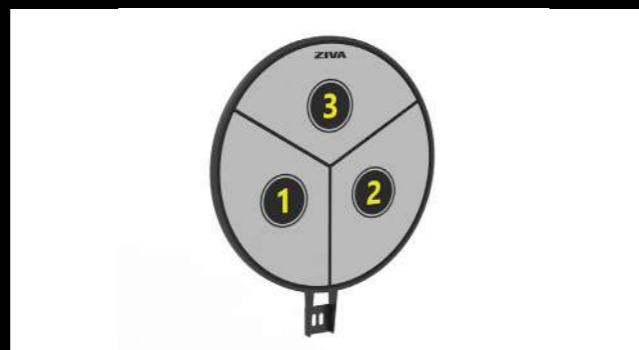

FIXED PARALLELS

Order Code

ZFS-XACS-6735



ADJUSTABLE PARALLELS

Order Code

ZFS-XACS-6736



PLYOMETRIC BOARD

Order Code

ZFS-XACS-6737



TORSO TRAINER

Order Code

ZFS-XACS-6739



DUMBBELL STORAGE

Order Code

ZFS-XACS-6745



WALL BALL TARGET

Order Code

ZFS-XACS-6738

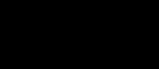

UNIVERSAL BAR STORAGE

Order Code

ZFS-XACS-6740



UNIVERSAL SHELF

Order Code

ZFS-XACS-6741



OLYMPIC DISC STORAGE

Order Code

ZFS-XACS-6742



OLYMPIC BUMPER STORAGE

Order Code

ZFS-XACS-6744



OLYMPIC BUMPER & BAR STORAGE

Order Code

ZFS-XACS-6743



POWERWAVE BAG STORAGE

Order Code

ZFS-XACS-6734



POWER CORE BAG STORAGE

Order Code

ZFS-XACS-6746

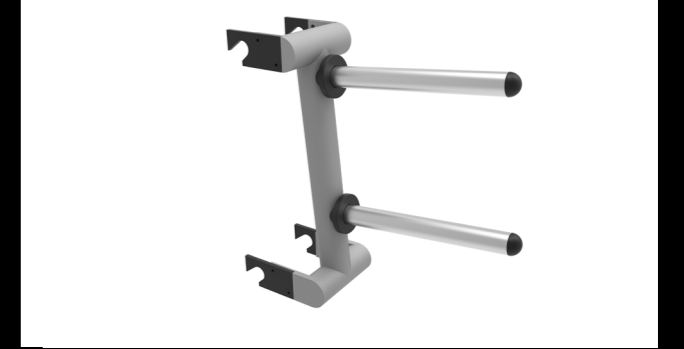

MAT STORAGE

Order Code

ZFS-XACS-6748



UNIVERSAL BOX

Order Code

ZFS-XACS-6749



TV ATTACHMENT

Order Code

ZFS-XACS-6773



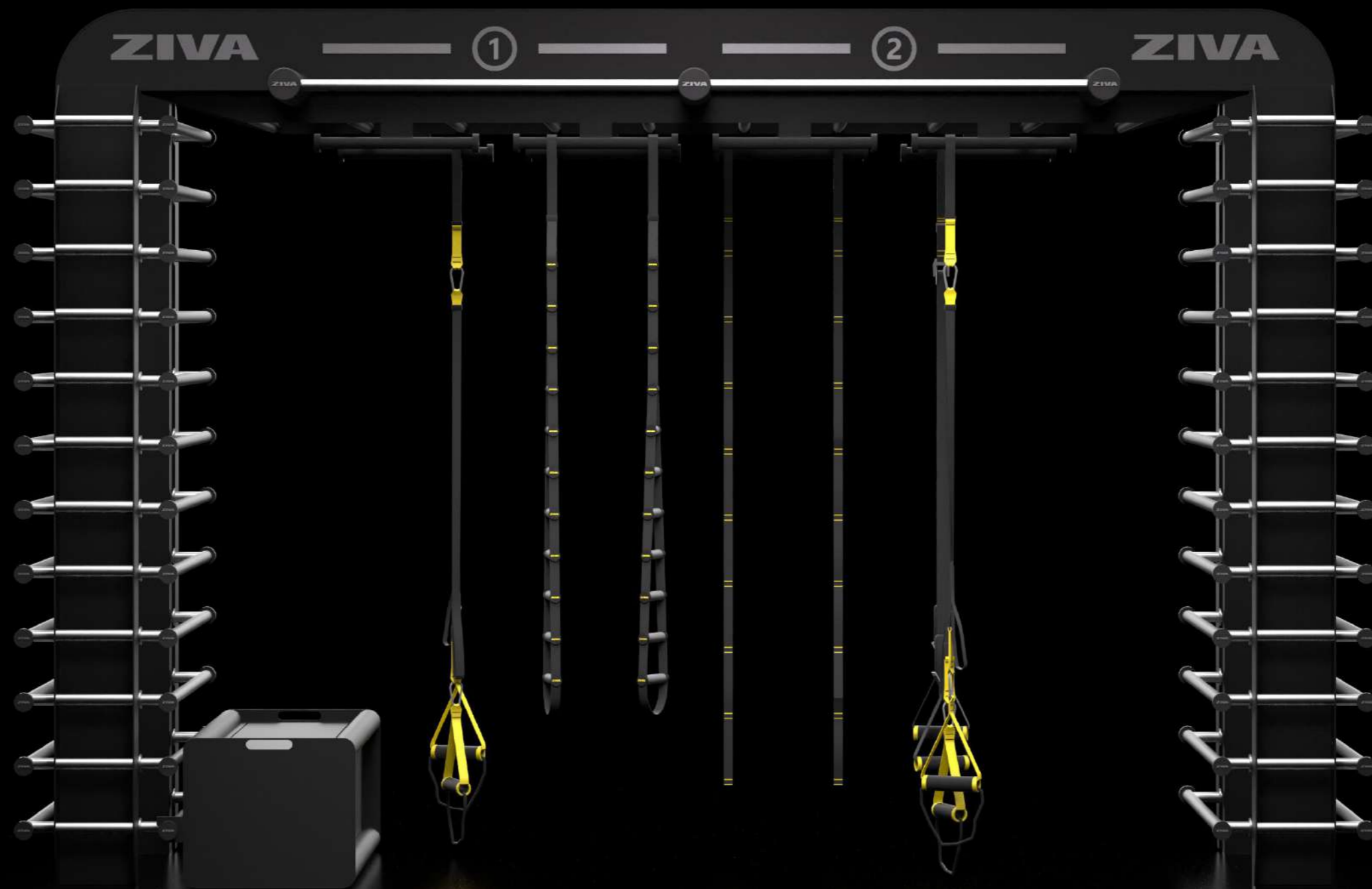

For more information on the full range of products in the INFINITY X range including bridges, customized, home, hotel and outdoor solutions please refer to the INFINITY X 2020 catalog or visit the dedicated website at www.zivainfinity.com

STRENGTH

The ageless training tools which have inspired fitness revolutions over and over again throughout the world. Free weights, benches, racks, and the other essential gym equipment to facilitate strength and hypertrophy training.

OZVO ex XP SL stZ







ZIVA

**24
ZIVA**

5
ZIVA

10
ZIVA

10
ZIVA

15
ZIVA

15
ZIVA

30
ZIVA

30
ZIVA



ZVO SOLID STEEL URETHANE DUMBBELLS

Features:

- Solid steel heads
- Premium hard-wearing imported urethane coating
- 1 - 60kg (2kg increments)
- Stainless steel ring at joint
- Ultra durable hard chrome plated grips in 32mm (1 - 10kg = 29mm, 12 - 20kg = 33mm, and 22 - 60kg = 35mm diameter grips.)
- Stainless steel grips are optional

Color Options

- Black / Yellow
- Black / Grey
- Blue



Order Code	Item Description
ZVO-DBPU-1584	ZVO Solid Steel Urethane Dumbbell Set 1-10kg (10 pairs), 110kg
ZVO-DBPU-1631	ZVO Solid Steel Urethane Dumbbell Set 2-20kg (10 pairs), 220kg
ZVO-DBPU-1632	ZVO Solid Steel Urethane Dumbbell Set 12-30kg (10 pairs), 420kg
ZVO-DBPU-1633	ZVO Solid Steel Urethane Dumbbell Set 22-30kg (5 pairs), 260kg
ZVO-DBPU-1634	ZVO Solid Steel Urethane Dumbbell Set 32-40kg (5 pairs), 360kg
ZVO-DBPU-1635	ZVO Solid Steel Urethane Dumbbell Set 42-50kg (5 pairs), 460kg
ZVO-DBPU-1636	ZVO Solid Steel Urethane Dumbbell Set 52-60kg (5 pairs), 560kg



ZVO SOLID STEEL URETHANE BARBELLS AND ZVO SOLID STEEL URETHANE EZ CURL BARBELLS

Features:

- Solid steel heads
- Premium hard-wearing imported urethane coating
- 10 - 20 = 2.5kg increments, 25 - 45kg = 5kg increments
- Stainless steel ring at joint
- Ultra durable hard chrome plated grips in 32mm (10 - 20kg) and 34mm (25 - 45kg) diameter grips

Color Options

- Black / Yellow
- Black / Grey
- Blue



Order Code	Item Description
ZVO-BSPU-1619	ZVO Solid Steel Urethane Barbell Set 10-20kg (5 pieces), 75kg
ZVO-BSPU-1580	ZVO Solid Steel Urethane Barbell Set 25-45kg (5 pieces), 175kg
ZVO-BSPU-1581	ZVO Solid Steel Urethane Barbell Set 10-45kg (10 pieces), 250kg
ZVO-BCPU-1601	ZVO Solid Steel Urethane EZ Curl Barbell Set 10-20kg (5 pieces), 75kg
ZVO-BCPU-1582	ZVO Solid Steel Urethane EZ Curl Barbell Set 25-45kg (5 pieces), 175kg
ZVO-BCPU-1583	ZVO Solid Steel Urethane EZ Curl Barbell Set 10-45kg (10 pieces), 250kg



ZVO URETHANE DUMBBELLS

Features:

- Solid steel heads
- Premium urethane surface
- 1 - 60kg (2kg increments)
- Stainless steel ring at joint
- Ultra durable hard chrome plated grips
(1 - 10kg = 29mm, 12 - 20kg = 33mm, and 22 - 60kg = 35mm diameter grips.)

Order Code

ZVO-DBPU-1301
ZVO-DBPU-1001
ZVO-DBPU-1002
ZVO-DBPU-1003
ZVO-DBPU-1004
ZVO-DBPU-1005
ZVO-DBPU-1006
ZVO-DBPU-1039

Item Description

ZVO Urethane Dumbbell Set 1-10kg (10 pairs), 110kg
ZVO Urethane Dumbbell Set 2-20kg (10 pairs), 220kg
ZVO Urethane Dumbbell Set 12-30kg (10 pairs), 420kg
ZVO Urethane Dumbbell Set 22-30kg (5 pairs), 260kg
ZVO Urethane Dumbbell Set 32-40kg (5 pairs), 360kg
ZVO Urethane Dumbbell Set 42-50kg (5 pairs), 460kg
ZVO Urethane Dumbbell Set 52-60kg (5 pairs), 560kg
ZVO Urethane Dumbbell Set 12-20kg (5 pairs), 160kg

Color Options

Yellow / Grey / Orange / Red



ZVO URETHANE BARBELLS AND ZVO URETHANE EZ CURL BARBELLS

Features:

- Solid steel heads
- Premium urethane surface
- Color urethane end caps
- 10 - 20kg in 2.5kg, 25 - 45kg in 5kg increments
- Ultra durable hard chrome plated grips in 32mm (10 - 20kg) and 34mm (25 - 45kg) diameter grips

Order Code

ZVO-BSPU-1101
ZVO-BSPU-1102
ZVO-BSPU-1103

ZVO-BCPU-1201
ZVO-BCPU-1202
ZVO-BCPU-1203

Item Description

ZVO Urethane Barbell Set 10-20kg (5 pieces), 75kg
ZVO Urethane Barbell Set 25-45kg (5 pieces), 175kg
ZVO Urethane Barbell Set 10-45kg (10 pieces), 250kg

ZVO Urethane EZ Curl Barbell Set 10-20kg (5 pieces), 75kg
ZVO Urethane EZ Curl Barbell Set 25-45kg (5 pieces), 175kg
ZVO Urethane EZ Curl Barbell Set 10-45kg (10 pieces), 250kg

Color Options

Yellow / Grey / Orange / Red





“ ZIVA is Basic Fit’s preferred free weights and functional training products partner in Europe. ZIVA delivers premium quality products and customized solutions for Basic Fit and our members and supports our growth in Europe. ”

Rene Moos
CEO
Basic Fit
Europe



ZVO URETHANE GRIP DISC

Features:

- Solid stainless steel insert
- Precision casting
- Available in blue or black with contrasting color logos and white weight indicators
- Distinct three color premium urethane surface coating

Order Code	Item Description
ZVO-DCPU-1618	ZVO Urethane Grip Disc 1.25kg
ZVO-DCPU-1612	ZVO Urethane Grip Disc 2.5kg
ZVO-DCPU-1613	ZVO Urethane Grip Disc 5kg
ZVO-DCPU-1614	ZVO Urethane Grip Disc 10kg
ZVO-DCPU-1615	ZVO Urethane Grip Disc 15kg
ZVO-DCPU-1616	ZVO Urethane Grip Disc 20kg
ZVO-DCPU-1617	ZVO Urethane Grip Disc 25kg
ZVO-DCPU-1575	ZVO Urethane Grip Discs 1000kg Set (94 pieces)
ZVO-DCPU-1576	ZVO Urethane Grip Discs 400kg Set (40 pieces)
ZVO-DCPU-1577	ZVO Urethane Grip Discs 300kg Set (36 pieces)
ZVO-DCPU-1578	ZVO Urethane Grip Discs 200kg Set (26 pieces)

Color Options

Black / Yellow
Black / Grey
Blue



ZVO URETHANE GRIP DISC W/ COLOR INSERT

Features:

- Solid stainless steel insert
- Precision casting
- Premium urethane surface coating

Color Options

Black / Yellow, Black / Grey, Black / Orange, Black / Red



Order Code	Item Description
ZVO-DCPU-1301	ZVO Urethane Grip Disc with Color Insert 1.25kg
ZVO-DCPU-1302	ZVO Urethane Grip Disc with Color Insert 2.5kg
ZVO-DCPU-1303	ZVO Urethane Grip Disc with Color Insert 5kg
ZVO-DCPU-1304	ZVO Urethane Grip Disc with Color Insert 10kg
ZVO-DCPU-1305	ZVO Urethane Grip Disc with Color Insert 15kg
ZVO-DCPU-1306	ZVO Urethane Grip Disc with Color Insert 20kg
ZVO-DCPU-1307	ZVO Urethane Grip Disc with Color Insert 25kg
ZVO-DCPU-1308	ZVO Urethane Grip Disc with Color Insert 1000kg Set (94 pieces)
ZVO-DCPU-1309	ZVO Urethane Grip Disc with Color Insert 400kg Set (40 pieces)
ZVO-DCPU-1310	ZVO Urethane Grip Disc with Color Insert 300kg Set (36 pieces)
ZVO-DCPU-1311	ZVO Urethane Grip Disc with Color Insert 200kg Set (26 pieces)



ZVO VIRGIN RUBBER GRIP DISCS

Features:

- Solid stainless steel insert
- Precision casting
- Durable virgin rubber surface coating

Color Options

Black / Yellow, Black / Grey, Black / Orange, Black / Red



Order Code	Item Description
ZVO-DCRB-2301	ZVO Virgin Rubber Grip Disc 1.25kg
ZVO-DCRB-2302	ZVO Virgin Rubber Grip Disc 2.5kg
ZVO-DCRB-2303	ZVO Virgin Rubber Grip Disc 5kg
ZVO-DCRB-2304	ZVO Virgin Rubber Grip Disc 10kg
ZVO-DCRB-2305	ZVO Virgin Rubber Grip Disc 15kg
ZVO-DCRB-2306	ZVO Virgin Rubber Grip Disc 20kg
ZVO-DCRB-2307	ZVO Virgin Rubber Grip Disc 25kg
ZVO-DCRB-2308	ZVO Virgin Rubber Grip Disc 1000kg Set (94 pieces)
ZVO-DCRB-2309	ZVO Virgin Rubber Grip Disc 400kg Set (40 pieces)
ZVO-DCRB-2310	ZVO Virgin Rubber Grip Disc 300kg Set (36 pieces)
ZVO-DCRB-2311	ZVO Virgin Rubber Grip Disc 200kg Set (26 pieces)





EX 5 PAIR HORIZONTAL DUMBBELL RACK

Features:

- Forward tilted saddles
- Non marking feet with option to bolt down
- 3mm thick steel frame
- Black or brushed steel panel options
- Baked powder coating

Dimensions:

Width: 145cm
Height: 82cm
Depth: 65cm
Weight: 65kg

Order Code

ZEX-DB05-7001

Item Description

EX 5 Pair Horizontal Dumbbell Rack



EX 10 PAIR HORIZONTAL DUMBBELL RACK

Features:

- Forward tilted saddles
- Non marking feet with option to bolt down
- 3mm thick steel frame
- Black or brushed steel panel options
- Baked powder coating

Dimensions:

Width: 262cm
Height: 82cm
Depth: 65cm
Weight: 105kg

Order Code

ZEX-DB10-7002

Item Description

EX 10 Pair Horizontal Dumbbell Rack



EX 10 PIECE BARBELL RACK

Features:

- Stores 10 barbells
- Vertical style frame
- Non marking feet with option to bolt down
- 3mm thick steel frame
- Black or brushed steel panel options
- Baked powder coating

Dimensions:

Width: 86cm
Height: 122cm
Depth: 79cm
Weight: 60kg

Order Code

ZEX-BB10-7004

Item Description

EX 10 Piece Barbell Rack



EX DISC STORAGE STATION

Features:

- Stores up to 25kg Olympic discs
- Vertical style frame
- Non marking feet with option to bolt down
- Black or brushed steel panel options
- Baked powder coating

Dimensions:

Width: 71cm
Height: 124cm
Depth: 42cm
Weight: 45kg

Order Code

ZEX-DTVS-7006

Item Description

EX Disc Storage Station



EX 1 - 10KG VERTICAL STUDIO DUMBBELL RACK

Features:

- Vertical style frame
- Baked powder coating
- 3mm thick steel frame
- Black or brushed steel panel options
- Stores 10 pairs (1 - 10kg studio dumbbells)
- Non marking feet with option to bolt down

Dimensions:

Width: 71cm
 Height: 163cm
 Depth: 42cm
 Weight: 60kg

Order Code

ZEX-DBVS-7005

Item Description

EX 1 - 10kg Vertical Studio Dumbbell Rack



“ Smart Fit selected ZIVA to be our official and strategic partner in Brasil and all over Latin America. ZIVA is able to give us consistency and perfect brand solution for the Free Weight, Functional and Sports Performance zones. The ZIVA combination of innovative designs, excellent product quality and service is a winning combination for us at Smart Fit all over the continent. ”

Thiago Somera
Supply Chain Director
Smart Fit / Grupo Bio Ritmo
South America





SL URETHANE DUMBBELLS

Features:

- Solid steel heads
- Knurled chrome plated grips (2 - 10kg = 29mm, 12 - 20kg = 33mm, and 22 - 60kg = 35mm diameter grips)
- Premium urethane surface coating
- 2.5 - 50kg (2.5kg increments)
- 2 - 50kg (2kg increments)

Order Code	Item Description
ZSL-PUDB-7351	SL Urethane Dumbbell Set 2.5-25kg (10 pairs)
ZSL-PUDB-7374	SL Urethane Dumbbell Set 2.5-37.5kg (15 pairs)
ZSL-PUDB-7352	SL Urethane Dumbbell Set 27.5-37.5kg (5 pairs)
ZSL-PUDB-7353	SL Urethane Dumbbell Set 40-50kg (5 pairs)
ZSL-PUDB-9045	SL Urethane Dumbbell Set 2-20kg (10 pairs)
ZSL-PUDB-9046	SL Urethane Dumbbell Set 22-40kg (10 pairs)
ZSL-PUDB-9047	SL Urethane Dumbbell Set 42-50kg (5 pairs)
ZSL-PUDB-9048	SL Urethane Dumbbell Set 2-50kg (25 pairs)

Color Options

Yellow / Grey / White / Red

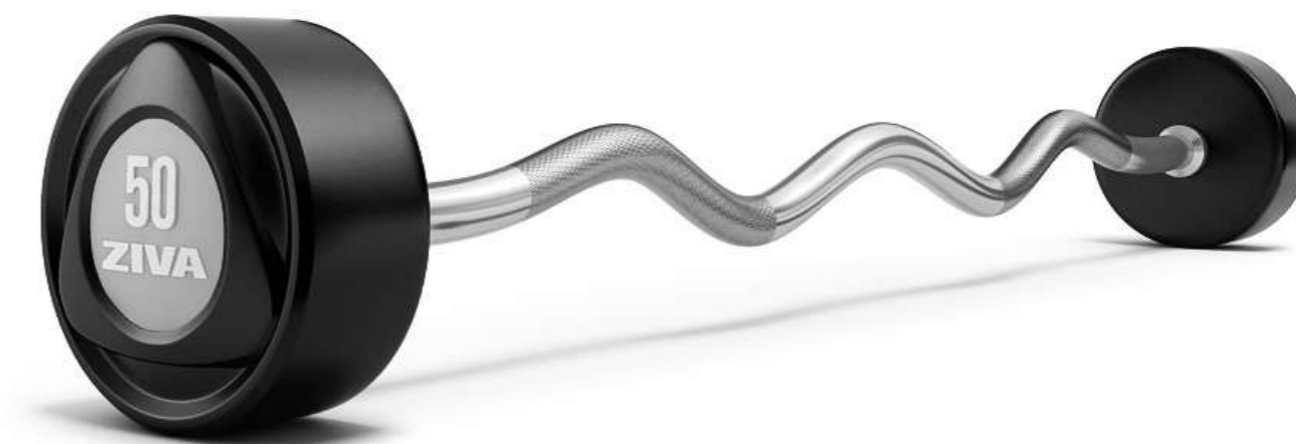

SL URETHANE BARBELLS AND SL URETHANE EZ CURL BARBELLS

Features:

- Solid steel heads
- Knurled chrome plated grips (10 - 20kg = 32mm and 25 - 45kg = 34mm diameter grips)
- Premium urethane surface coating
- 10 - 20kg = 2.5kg increments, 25 - 45kg = 5kg increments

Order Code	Item Description
ZSL-PUBB-8371	SL Urethane Barbell 10-45kg (10 pieces), 250kg
ZSL-PUBB-8372	SL Urethane Barbell 10-20kg (5 pieces), 75kg
ZSL-PUBB-8373	SL Urethane Barbell 25-45 (5 pieces), 175kg
ZSL-PUEZ-9371	SL Urethane EZ Curl Barbell 10-45kg (10 pieces), 250kg
ZSL-PUEZ-9372	SL Urethane EZ Curl Barbell 10-20kg (5 pieces), 75kg
ZSL-PUEZ-9373	SL Urethane EZ Curl Barbell 25-45 (5 pieces), 175kg

Color Options

Yellow / Grey / White / Red





SL VIRGIN RUBBER DUMBBELLS

Features:

- Solid steel heads
- Knurled chrome grips
(2.5 - 10kg = 29mm, 12.5 - 20kg = 33mm, 22.5 - 50kg = 35mm diameter grips)
- Durable virgin rubber surface coating
- 2.5 - 50kg (2.5kg increments)

Order Code

Item Description

ZSL-RBDB-4441	SL Virgin Rubber Dumbbell with Chrome Handle Set 2.5-25kg (10 pairs)
ZSL-RBDB-4442	SL Virgin Rubber Dumbbell with Chrome Handle Set 27.5-37.5kg (5 pairs)
ZSL-RBDB-4443	SL Virgin Rubber Dumbbell with Chrome Handle Set 40-50kg (5 pairs)
ZSL-RBDB-4444	SL Virgin Rubber Dumbbell with Chrome Handle Set 2.5-37.5kg (15 pairs)

Color Options

Yellow / Grey / Red



SL VIRGIN RUBBER BARBELLS AND SL VIRGIN RUBBER EZ CURL BARBELLS

Features:

- Solid steel heads
- Knurled chrome plated grips
(10 - 20kg = 32mm, 25 - 45kg = 34mm diameters)
- Durable virgin rubber surface coating
- 10 - 20kg (2.5kg increments) & 25 - 45kg (5kg increments)

Order Code

Item Description

ZSL-RBBB-4492	SL Virgin Rubber Barbell Set 10-45kg (10 pieces)
ZSL-RBBB-4493	SL Virgin Rubber Barbell Set 10-20kg (5 pieces)
ZSL-RBBB-4494	SL Virgin Rubber Barbell Set 25-45kg (10 pieces)
ZSL-RBEZ-4495	SL Virgin Rubber EZ Curl Barbell Set 10-45kg (10 pieces)
ZSL-RBEZ-4496	SL Virgin Rubber EZ Curl Barbell Set 10-20kg (5 pieces)
ZSL-RBEZ-4497	SL Virgin Rubber EZ Curl Barbell Set 25-45kg (10 pieces)

Color Options

Yellow / Grey / Red





Color Options

Yellow / Grey / White / Red



SL URETHANE DUMBBELLS WITH URETHANE GRIPS

Features:

- Solid steel heads
- Texture urethane coated grips (34mm diameter)
- Premium urethane surface coating
- 2.5kg increments up to 25kg

Order Code	Item Description
ZSL-PUDB-7375	SL Urethane Dumbbell with Urethane Grips Set 2.5-25kg (10 pairs)



Color Options

Yellow / Grey / Red



SL VIRGIN RUBBER DUMBBELL WITH URETHANE GRIPS SET

Features:

- Solid steel heads
- Texture urethane coated grips
- Durable virgin rubber surface coating (34mm diameter)
- 2.5kg increments up to 25kg

Order Code	Item Description
ZSL-RBDB-4445	SL Virgin Rubber Dumbbell with Urethane Grips Set 2.5-25kg (10 pairs)

SL URETHANE GRIP DISCS

Features:

- Solid stainless steel insert
- Precision casting
- Premium urethane surface coating

Order Code	Item Description
ZSL-DCPU-3961	SL Urethane Grip Disc 1.25kg
ZSL-DCPU-3962	SL Urethane Grip Disc 2.5kg
ZSL-DCPU-3963	SL Urethane Grip Disc 5kg
ZSL-DCPU-3964	SL Urethane Grip Disc 10kg
ZSL-DCPU-3965	SL Urethane Grip Disc 15kg
ZSL-DCPU-3966	SL Urethane Grip Disc 20kg
ZSL-DCPU-3967	SL Urethane Grip Disc 25kg



Color Options

Black or Grey



SL VIRGIN RUBBER GRIP DISCS

Features:

- Solid stainless steel insert
- Precision casting
- Virgin black rubber surface coating

Order Code	Item Description
ZSL-DCRB-2492	SL Virgin Rubber Grip Disc 1.25kg
ZSL-DCRB-2493	SL Virgin Rubber Grip Disc 2.5kg
ZSL-DCRB-2494	SL Virgin Rubber Grip Disc 5kg
ZSL-DCRB-2495	SL Virgin Rubber Grip Disc 10kg
ZSL-DCRB-2496	SL Virgin Rubber Grip Disc 15kg
ZSL-DCRB-2497	SL Virgin Rubber Grip Disc 20kg
ZSL-DCRB-2498	SL Virgin Rubber Grip Disc 25kg

Color Options

Yellow / Grey / Red Logo



“The foundation of every great partnership is commitment, care, responsibility, expertise and trust combined with a get shit done attitude. The team at ZIVA embody and practice these values in all that they do and that is why Anytime Fitness Asia have chosen ZIVA to support our growth objectives across the region.”

Mr Maurice Levine
Master Franchisee and CEO
Anytime Fitness
Asia





XP URETHANE DUMBBELLS

Features:

- Solid steel heads
- Premium urethane surface
- 2 - 50kg (2 kg increments)
- 2.5 - 50kg (2.5kg increments)
- Stainless steel ring at joint
- Contoured grips
- Durable chrome plated grips (2 - 20 kg = 30mm, 22 - 50kg = 34mm)

Order Code	Item Description
ZXP-DBPU-7719	XP Urethane Dumbbell Set (20 pairs) 2.5-50kg
ZXP-DBPU-7720	XP Urethane Dumbbell Set (10 pairs) 27.5-50kg
ZXP-DBPU-8686	XP Urethane Dumbbell Set (10 pairs) 2-20kg
ZXP-DBPU-8688	XP Urethane Dumbbell Set (25 pairs) 2-50kg
ZXP-DBPU-8685	XP Urethane Dumbbell Set (10 pairs) 22-40kg
ZXP-DBPU-8658	XP Urethane Dumbbell Set (5 pairs) 42-50kg

Color Options

Yellow or White logo



XP URETHANE BARBELLS AND XP URETHANE EZ CURL BARBELLS

Features:

- Solid steel heads
- Premium urethane surface
- 10 - 20kg in 2.5kg, 25 - 45kg in 5kg increments
- Durable chrome grips in 32mm (10 - 20kg) and 34mm (25 - 45kg) diameter grips

Order Code	Item Description
ZXP-BSPU-8110	XP Urethane Barbell Set (5 pieces) 10-20kg, 75kg
ZXP-BSPU-8111	XP Urethane Barbell Set (5 pieces) 25-45kg, 175kg
ZXP-BSPU-8112	XP Urethane Barbell Set (10 pieces) 10-45kg, 250kg
ZXP-BCPU-8125	XP Urethane EZ Curl Barbell Set (5 pieces) 10-20kg, 75kg
ZXP-BCPU-8126	XP Urethane EZ Curl Barbell Set (5 pieces) 25-45kg, 175kg
ZXP-BCPU-8127	XP Urethane EZ Curl Barbell Set (10 pieces) 10-45kg, 250kg

Color Options

Yellow or White logo



XP RUBBER GRIP DISCS

Features:

- Solid stainless steel insert
- Precision casting
- Virgin black rubber surface coating

Order Code	Item Description
ZXP-DCRB-8140	XP Rubber Grip Disc 1000kg Set (94 pieces)
ZXP-DCRB-8141	XP Rubber Grip Disc 400kg Set (40 pieces)
ZXP-DCRB-8142	XP Rubber Grip Disc 300kg Set (36 pieces)
ZXP-DCRB-8143	XP Rubber Grip Disc 200kg Set (26 pieces)
ZXP-DCRB-8144	XP Rubber Grip Disc 1.25kg
ZXP-DCRB-8145	XP Rubber Grip Disc 2.5kg
ZXP-DCRB-8146	XP Rubber Grip Disc 5kg
ZXP-DCRB-8147	XP Rubber Grip Disc 10kg
ZXP-DCRB-8148	XP Rubber Grip Disc 15kg
ZXP-DCRB-8149	XP Rubber Grip Disc 20kg
ZXP-DCRB-8150	XP Rubber Grip Disc 25kg



ST2 10 PAIR HORIZONTAL DUMBBELL RACK

Features:

- Horizontal style frame
- Forward tilted saddles
- Baked powder coating
- 3mm thick round tube steel
- Non marking feet with option to bolt down

Dimensions:

Width: 226cm
Height: 80.8cm
Depth: 66.5cm
Weight: 69kg



Frame Color Options:

Black or Silver



Order Code	Item Description
ZST-DBST-5393	ST2 10 Pair Horizontal Dumbbell Rack

ST2 5 PAIR HORIZONTAL DUMBBELL RACK

Features:

- Horizontal style frame
- Forward tilted saddles
- Non marking feet with option to bolt down
- Baked powder coating

Dimensions:

Width: 111cm
Height: 80.8cm
Depth: 66.5cm
Weight: 45kg



Frame Color Options:

Black or Silver



Order Code	Item Description
ZST-DBST-5392	ST2 5 Pair Horizontal Dumbbell Rack

ST2 15 PAIR 3-TIER DUMBBELL RACK

Features:

- Three tier style frame
- 3mm thick round tube steel
- Forward tilted saddles
- Non marking feet with option to bolt down

Dimensions:

Width: 255cm
Height: 116cm
Depth: 97.5cm
Weight: 140kg



Frame Color Options:

Black or Silver



Order Code	Item Description
ZST-DBST-5399	ST2 15 Pair 3-Tier Dumbbell Rack

ST2 10 PAIR DUMBBELL VERTICAL RACK

Features:

- Vertical style frame
- Baked powder coating
- 3mm thick round tube steel
- Stores 10 pairs (up to 20kg)
- Non marking feet with option to bolt down

Dimensions:

Width: 99.7cm
Height: 133.4cm
Depth: 83.1cm
Weight: 65kg



Frame Color Options:

Black or Silver



Order Code	Item Description
ZST-DBXB-5397	ST2 10 Pair Dumbbell Vertical Rack

ST2 10 PIECE BARBELL RACK

Features:

- Stores 10 barbells
- Vertical style frame
- Baked powder coating
- 3mm thick round tube steel
- Non marking feet with option to bolt down

Dimensions:

Width: 89.4cm
Height: 131.4cm
Depth: 96.8cm
Weight: 53kg

Order Code	Item Description
ZST-BBRK-5391	ST2 10 Piece Barbell Rack



Frame Color Options:
Black or Silver



ST2 DISC STORAGE RACK

Features:

- Stores up to 25kg Olympic discs
- Vertical style frame
- Built in bar storage
- Non marking feet with option to bolt down
- Polished stainless steel storage spindles
- Baked powder coating

Dimensions:

Width: 73.3cm
Height: 110cm
Depth: 62cm
Weight: 33kg

Order Code	Item Description
ZST-ODRK-5394	ST2 Disc Storage Rack



Frame Color Options:
Black or Silver



ST2 5 PIECE BARBELL RACK

Features:

- Stores 5 barbells
- Vertical style frame
- Baked powder coating
- 3mm thick round tube steel
- Non marking feet with option to bolt down

Dimensions:

Width: 72cm
Height: 132cm
Depth: 96.8cm
Weight: 37kg

Order Code	Item Description
ZST-BBRK-5390	ST2 5 Piece Barbell Rack



Frame Color Options:
Black or Silver



ST2 TRI-LEG DISC STORAGE STATION

Features:

- Stores up to 25kg Olympic discs
- Vertical style frame
- Built in bar storage
- Non marking feet with option to bolt down
- Polished stainless steel storage spindles
- Baked powder coating

Dimensions:

Width: 120.5cm
Height: 133.6cm
Depth: 105cm
Weight: 64kg

Order Code	Item Description
ZST-DCTR-5411	ST2 Tri-Leg Disc Storage Station



Frame Color Options:
Black or Silver





ZVO-LBHC-2953



ZVO-LBHC-2954



ZVO-LBHC-2966

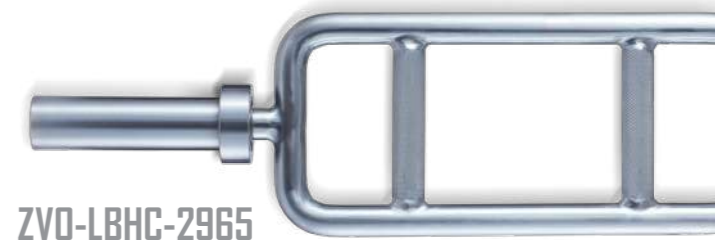

ZVO-LBHC-2965

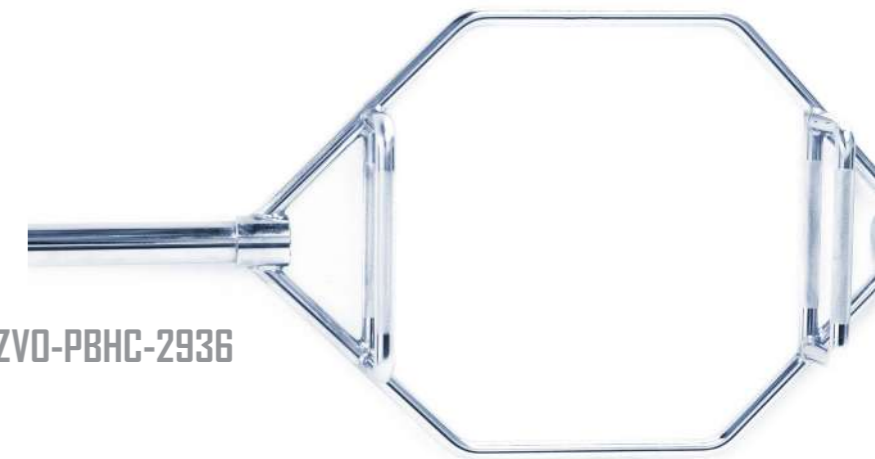

ZVO-PBHC-2936

ZVO OLYMPIC BARS

Features:

- Fits standard Olympic size discs
- Hard chrome coating
- Long-lasting use without chipping or flaking
- Capped ends for reduced maintenance

Order Code

ZVO-LBHC-2953
 ZVO-LBHC-2954
 ZVO-HCOB-2965
 ZVO-HCOB-2966
 ZVO-PBHC-2936
 ZXP-OBCC-0436

Item Description

ZVO Olympic 1.8m Bar - 30mm
 ZVO Olympic 1.5m Bar - 30mm
 ZVO Olympic 76cm Tricep Bar - 30mm
 ZVO Olympic 1.2m EZ Curl Bar - 30mm
 ZVO Olympic 1.4m Hex Trap Bar - 25mm
 ZVO Olympic Monster Clamp Collars

Olympic Monster Clamp Collars available in:

Black





ZVO PREMIUM OLYMPIC BARS

Features:

- Fits standard Olympic size discs
- Premium hard chrome coated 50mm sleeves
- Ball bearings for smooth and even rotation during lifts
- Capped ends for reduced maintenance
- Lifetime warranty

Order Code	Item Description
ZVO-HCOB-2985	ZVO Premium Olympic 2.01m Bar - 25mm <small>700kgs Tested, 230K PSI, Brass Bushing, Needle Bearings, Weight: 15kgs</small>
ZVO-HCOB-2991	ZVO Premium Olympic 2.01m Bar - 25mm <small>700kgs Tested, 230K PSI, Brass Bushing, Needle Bearings, Weight: 15kgs</small>
ZVO-HCOB-2990	ZVO Premium Olympic 2.2m Bar - 28mm <small>900kgs Tested, 230K PSI, Brass Bushing, Needle Bearings, Weight: 20kgs</small>
ZVO-HCOB-2988	ZVO Premium Olympic 2.2m Bar - 28mm <small>900kgs Tested, 230K PSI, Brass Bushing, Needle Bearings, Weight: 20kgs</small>
ZVO-HCOB-2989	ZVO Technical 1.7m Bar - 25mm <small>450kgs Tested, 230K PSI, Brass Bushing, Needle Bearings, Weight: 10kgs</small>

OLYMPIC BAR STORAGE STAND

Features:

- Charcoal powder coated finish
- 3mm thick steel
- Stores up to 9 bars

Dimensions:

- Length: 46cm
- Width: 46cm
- Height: 19.5cm
- Weight: 32kg

Order Code

ZXP-OBSS-7217

Item Description

Olympic Bar Storage Stand

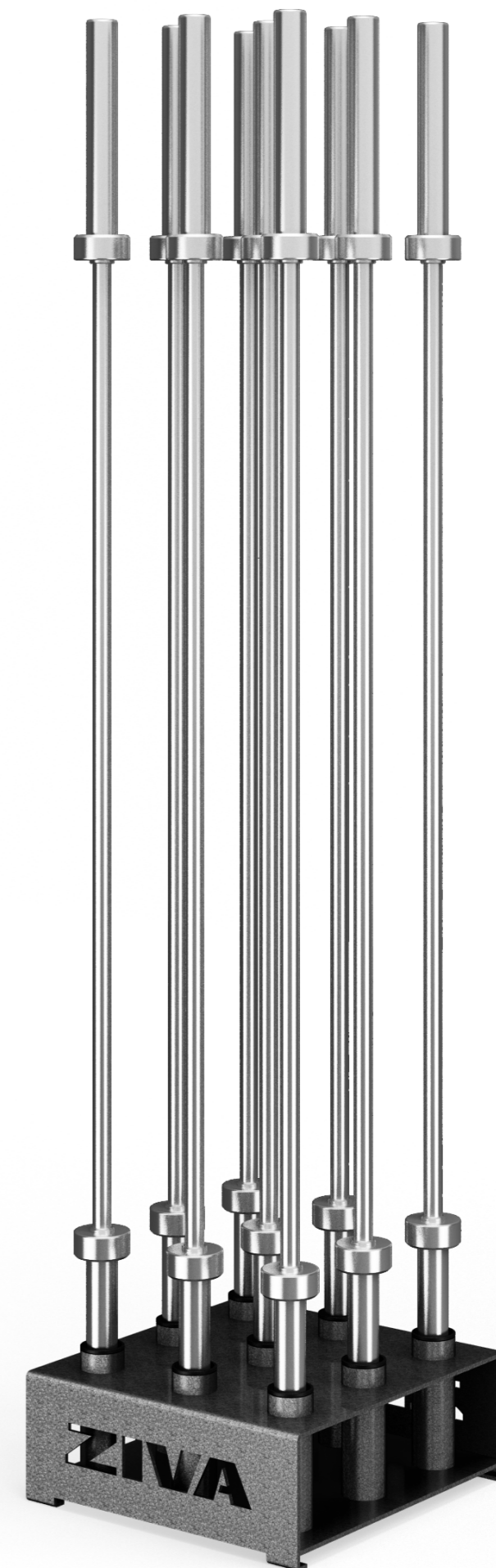

“ With this exclusive collaboration Matrix Fitness and ZIVA found each other in their common mission: creating strong, smart and beautiful fitness and training products. With ZIVA we have created an extensive portfolio of products that provide superior performance and durability, providing us the opportunity to fully service our customers. ”

Marco Vonk
Managing Director
Matrix Fitness
Benelux, Europe





ST2 1 - 10KG STUDIO DUMBBELL RACK

Features:

- Compact design with minimal footprint
- Rubber cushioned saddles
- Powder coated finish
- Steel wire saddles
- Non marking feet with option to bolt down
- Stores 1 - 10kg studio dumbbell pairs

Dimensions:

Width: 153.5cm
 Height: 92cm
 Depth: 54cm
 Weight: 50kg

Frame Color Options:

Black or Silver



Order Code	Item Description
ZST-VS10-5396	ST2 1-10kg Studio Dumbbell Rack



ZVO URETHANE FUNCTIONAL TRIBELL STUDIO DUMBBELLS

Features:

- Comfortable ergonomic grips
- Premium urethane surface
- Flat surfaces prevent rolling
- 1 -10kg (1kg increments)

Order Code	Item Description
ZVO-PUTF-3081	ZVO Urethane Functional Tribell 1kg - 10kg Set



Color Options

Yellow / Black / Grey or Orange Endcap



SL STEEL VIRGIN RUBBER FUNCTIONAL TRIBELL STUDIO DUMBBELLS

Features:

- Unique Tribell shape
- Comfortable ergonomic grips
- Durable virgin rubber surface
- Flat surfaces prevent rolling
- 1 - 10kg (1kg increments)

Order Code	Item Description
ZSL-RBST-2712	SL Steel Virgin Rubber Functional Tribell 1-10kg Set



Color Options

Black Endcap with Yellow / Grey or Red logo





EX POWER RACK WITH STORAGE

Features:

- Laser cut holes
- Powder coated finish
- 3mm thick steel frame
- Zinc coated hardware
- Six chromed bumper plate storage posts
- One pair of J-Cups
- Recommended to bolt to the floor
- Single pull-up bar & cross beam
- Two inside safety spotter arms (PU plastic protection coating)
- Multiple band connection points

POWER RACK LIFTING PLATFORM

Features:

- 50mm x 25mm (2" x 1") steel frame
- Laser cut and precision bent gussets
- Bolt together design
- Rubber tiles
- Bamboo wood center
- Does not need to be bolted to the ground
- Designed to fit the EX and XP power rack

Dimensions:

Width: 255.5cm
Length: 367.5cm
Weight: 202kg

Order Code	Item Description
ZEX-RKFL-6889	EX Power Rack with Storage

Order Code	Item Description
ZXP-PRCR-8949	XP Power Rack Lifting Platform





EX HALF RACK WITH STORAGE

Features:

- Laser cut holes
- Powder coated finish
- 3mm thick steel frame
- Zinc coated hardware
- Six chromed bumper plate storage posts
- One pair of J-Cups + safety arms
- Recommended to bolt to the floor
- Single pull-up bar & cross beam

HALF RACK LIFTING PLATFORM

Features:

- Designed to fit into the Ziva XP Half Rack
- 50 mm x 25 mm (2" x 2") steel frame
- Laser cut and precision bent gussets
- Bolt together design
- Rubber tiles
- Bamboo wood center
- Does not need to be bolted to the ground
- Designed to fit the EX and XP power rack

Dimensions:

Overall length including tongue: 3m
 Width: 250cm
 Length: 150cm
 Weight: 203 kg

Order Code

ZEX-RKHF-6888

Item Description

EX Half Rack with Storage

Order Code

ZXP-HRCR-8999

Item Description

XP Half Rack Lifting Platform



XP POWER RACK WITH STORAGE

Features:

- Laser cut holes (50mm spacing) and numbering system
- Hard wearing powder coated finish
- 3mm thick steel 3" x 3" (75 x 75mm) frame
- 24mm zinc coated hardware
- Eight chromed bumper plate storage posts
- One pair of J-Cups
- Additional holes at base for band for accessories attachment
- Must be bolted to the floor
- Two inside safety spotter arms (UMHW plastic protection coating)
- Single pull-up bar & cross beam

Order Code

ZXP-RKFL-7208
ZXP-RGAT-0977

Item Description

XP Power Rack with Storage
XP Pivot Plate Landmine Attachment

Dimensions:

Height: 236.2cm
Width: 127.0cm
Depth: 200.7cm
Weight: 223.6kg

XP RIGS Color Options:

Black roof / Black frame
Red roof / Black frame
Yellow roof / Black frame



XP HALF RACK WITH STORAGE

Features:

- Laser cut holes (50mm spacing) and numbering system
- Hard wearing powder coated finish
- 3mm thick steel 3" x 3" (75 x 75mm) frame
- 24mm zinc coated hardware
- Eight chromed bumper plate storage posts
- One pair of J-Cups
- Additional holes at base for band for accessories attachment
- Must be bolted to the floor
- Two safety spotter arms
- Single pull-up bar & cross beam

Order Code

ZXP-RKHF-7206
ZXP-RGAT-0977

Item Description

XP Half Rack with Storage
XP Pivot Plate Landmine Attachment

Dimensions:

Height: 236.2cm
Width: 127.0cm
Depth: 160.0cm
Weight: 177.4kg

XP RIGS Color Options:

Black roof / Black frame
Red roof / Black frame
Yellow roof / Black frame







-10° TO 80°



EX F-I-D BENCH

Features:

- 3.0mm thick steel frame
- Adjustable seat bottom (0 - 40°) & back (-10 - 80°)
- Cushioned rubber feet or bolt down option
- Powder coated finish
- High quality cushion surface with double stitches for better stability

Dimensions:

- Length: 140cm
- Width: 60cm
- Height: 55cm
- Weight: 40kg

Order Code

ZEX-XFID-6762

Item Description

EX F-I-D Bench

“ We rely on ZIVA for all our free weights and functional equipment needs. Excellent equipment, good value and great service from ZIVA at a local level. Delivery times have kept up with our aggressive build program and we are a happy customer. I like the fact ZIVA keeps evolving with the changing trends in the industry and endeavor to stay ahead of the curve. ”

Mike Lamb
CEO
Jetts 24 Hour Fitness
Asia





EX ABDOMINAL BENCH

Features:

- 3.0mm steel frame
- Powder coated finish
- Cushioned rubber feet with bolt down option
- Adjustable back angles (-30° - 0°)
- High quality cushion surface with double stitches for better stability

Dimensions:

- Length: 175cm
- Width: 100cm
- Height: 70cm
- Weight: 60kg

Order Code

ZEX-XABD-6763

Item Description

EX Abdominal Bench



EX OLYMPIC FLAT BENCH WITH STORAGE

Features:

- 3.0mm thick steel frame
- 4 built in storage for Olympic standard sized discs
- Powder coated finish
- Cushioned rubber feet with bolt down option
- Hard PU sandwiched saddle preserves Olympic bar knurling
- High quality cushion surface with double stitches for better stability

Dimensions:

- Length: 155cm
- Width: 180cm
- Height: 135cm
- Weight: 70kg

Order Code

ZEX-XOFS-6754

Item Description

EX Olympic Flat Bench with Storage



EX OLYMPIC INCLINE BENCH WITH STORAGE

Features:

- 3.0mm thick steel frame
- 30° incline angle
- Steel spotters platform
- Adjustable seat height
- 4 built in storage for Olympic standard sized discs
- Powder coated finish
- Cushioned rubber feet with bolt down option
- Hard PU sandwiched saddle preserves Olympic bar knurling
- High quality cushion surface with double stitches for better stability

Dimensions:

- Length: 205cm
- Width: 180cm
- Height: 145cm
- Weight: 110kg

Order Code

ZEX-XOIS-6756

Item Description

EX Olympic Incline Bench with Storage



EX OLYMPIC DECLINE BENCH WITH STORAGE

Features:

- 3.0mm thick steel frame
- 20° decline angle
- Double stitched upholstery
- Built in storage Olympic standard sized discs
- Double powder coated finish
- Cushioned rubber feet with bolt down option
- 4 built in pegs for disc storage
- Hard PU sandwiched saddle preserves Olympic bar knurling
- High quality cushion surface with double stitches for better stability

Dimensions:

- Length: 205cm
- Width: 180cm
- Height: 135cm
- Weight: 95kg

Order Code

ZEX-XODS-6760

Item Description

EX Olympic Decline Bench with Storage



Can store 2 x dumbbells or barbells

EX SCOTT CURL BENCH

Features:

- 3.0mm thick steel frame
- Powder coated finish
- Cushioned rubber feet with bolt down option
- Hard wearing padding
- Adjustable seat height to enable multiple exercise positions
- Hard PU wear strips protect the metal surfaces and barbell knurling
- High quality cushion surface with double stitches for better stability

Dimensions:

- Length: 140cm
- Width: 90cm
- Height: 90cm
- Weight: 65kg

Order Code	Item Description
ZEX-XSCT-6758	EX Scott Curl Bench



EX UTILITY BENCH

Features:

- 3.0mm thick steel frame
- 80° back angle for comfort and safety
- Powder coated finish
- Cushioned rubber feet with bolt down option
- High quality cushion surface with double stitches for better stability

Dimensions:

- Length: 95cm
- Width: 85cm
- Height: 130cm
- Weight: 40kg

Order Code	Item Description
ZEX-XUTL-6759	EX Utility Bench



EX HYPER EXTENSION BENCH

Features:

- 3.0mm thick steel frame
- Powder coated finish
- Cushioned rubber feet with bolt down option
- Adjustable pad height
- High quality cushion surface with double stitches for better stability

Dimensions:

- Length: 150cm
- Width: 90cm
- Height: 110cm
- Weight: 45kg

Order Code

ZEX-XHEX-6764

Item Description

EX Hyper Extension Bench



EX FLAT BENCH

Features:

- 3.0mm thick steel frame
- Powder coated finish
- Cushioned rubber feet with bolt down option
- High quality cushion surface with double stitches for better stability

Dimensions:

- Length: 135cm
- Width: 80cm
- Height: 40cm
- Weight: 30kg

Order Code

ZEX-XFLT-6752

Item Description

EX Flat Bench

“We enjoy a great working relationship with ZIVA, where we are always assured of conscientious and pro-active account management.”

Simon Flint

CEO Evolution Wellness

Fitness First and Celebrity Fitness

Asia



PERFORMANCE

A blend of established and contemporary training tools catered to athletic and performance training environments. Products popularly utilized for speed, balance, power, and other types of competitive modalities.



XP

SL



SIGNATURE

OZVO

PRO•FT





ZIVA
O

15.
6"
ZIVA

30.
12"
ZIVA

45.
18"
ZIVA

60.
ZIVA

30.
12"
ZIVA

15.
6"
ZIVA

45.
18"
ZIVA

15.
6"
ZIVA

30.
12"
ZIVA

45.
18"
ZIVA

15.
6"
ZIVA

60.
24"
ZIVA



EX FUNCTIONAL TRAINING STATION

With Pull up bar, 2 x suspension points, 2 x rope pull bars, TV Bracket (TV not included)

Features:

- 200mm wide main frame
- Full commercial 3mm thick steel
- 16mm bolts
- Floor mounted with safety extensions for extra stability
- Hard wearing powder coating
- Note: Shelving positions can be changed to suit your own set up

Dimensions:

Length: 330.6cm
 Depth: 209.6cm
 Height: 235.0cm
 Weight: 440kg

ZIVA Expert recommends per shelf: 5 x Slam Balls, 4 x Wall Ball, 8 x Power Core Bags, 5 x med balls, 5 pairs Hexagon Dumbbells, 6 x Kettlebells, multiple small accessories

Order Code	Item Description
ZEX-SSMF-0770	EX Functional Training Station
ZEX-SSTV-0799	Functional Station TV Bracket



EX FUNCTIONAL STRETCH STATION

With Pull up bar, 2 x suspension points, 2 x rope pull bars, 2 x Rope Pull bars, 10 x shelves, TV Bracket (TV not included)

Features:

- 200mm wide main frame
- Full commercial 3mm thick steel
- 16mm bolts
- Floor mounted with safety extensions for extra stability
- Hard wearing powder coating
- Note: Shelving positions can be changed to suit your own set up

Dimensions:

Length: 330.6cm
 Depth: 209.6cm
 Height: 235.0cm
 Weight: 390kg

ZIVA Expert recommends: 20 x Mats, 2 x Anti-Burst Core-Fit Balls, Multiple foam rollers, 1 x Balance ball, multiple accessories

Order Code	Item Description
ZEX-SSMF-0771	EX Functional Stretch Station
ZEX-SSTV-0799	Functional Station TV Bracket

y = 235cm

y = 155cm

y = 65cm

y = 65cm

x = 330.6cm

z = 134cm





XP MODULAR FUNCTIONAL TRAINING STATION

Features:

- Wall mounted or floor mounted
- Multi-grip roof serve as additional suspension zones
- Includes 1 flying pull-up bar, 4 D-handles and 1 storage basket
- Universal shelves store a variety of functional equipment and accessories

Dimensions:

Width: 201.2cm
Height: 248.6cm

Depth: 200cm
Weight: 400kg

Accessories

Order Code

ZXP-RGAT-0968
ZFS-SQLD-7950
ZFS-SQCR-8088
ZXP-RGAT-0775
ZXP-RGAT-0776
ZXP-RGAT-0777

Item Description

Body Pump Storage Attachment
Station Connection Ladder
Storage Station Basket
Accessory Storage Attachment
Balance Ball Holder Attachment
Foam Roller Holder Attachment

Order Code

ZFS-SQCR-8039

Item Description

XP Modular Functional Training Station





XP WALL STORAGE WITH PULL UP BAR

Features:

- 75 x 100mm steel frame
- Floor mounted
- Laser cut and precision bent gussets
- Bolt together design

Dimensions:

- Length: 122.5cm
- Depth: 240cm
- Height: 105cm
- Weight: 190kg

Order Code

ZXP-RKHF-7239

Item Description

XP Wall Storage with Pull up bar 42" Wide Station

XP WALL STORAGE WITH PULL UP BAR 72" (SINGLE X 1)

Features:

- 75 x 100mm steel frame
- Laser cut and precision bent gussets
- Universal shelves
- Stores wall balls, kettlebells, medicine balls, slam balls, dumbbells, and anything you can sit on the shelf
- Floor mounted
- Bolt together design

Dimensions:

- Length: 199cm
- Depth: 240cm
- Height: 101cm
- Weight: 240kg

Order Code

ZXP-RKHF-7246

Item Description

XP Wall Storage with Pull up bar - Single 72" Wide Station (Single x 1)

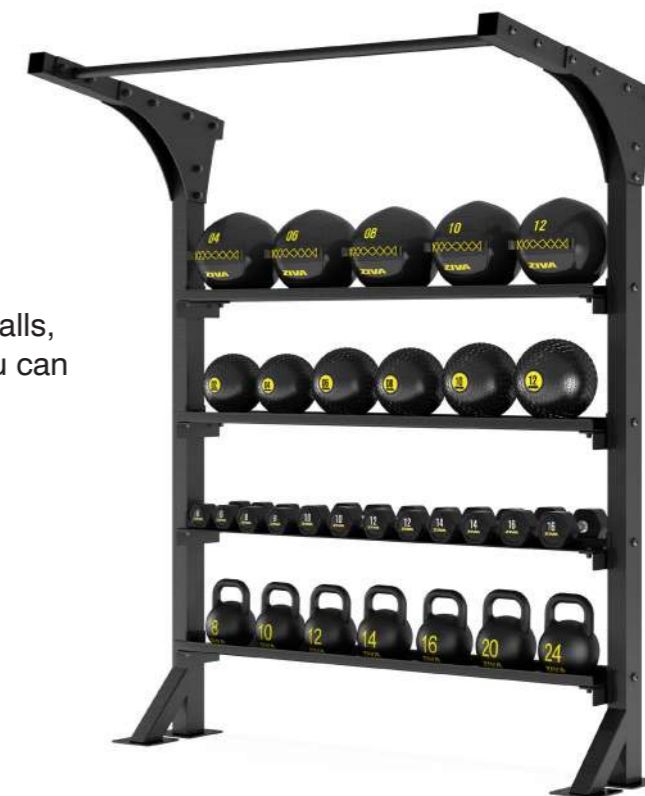

XP WALL STORAGE WITH PULL UP BAR 72" (DOUBLE X 2)

Features:

- 75 x 100mm steel frame
- Laser cut and precision bent gussets
- Universal shelves
- Stores wall balls, kettlebells, medicine balls, slam balls, dumbbells, and anything you can sit on the shelf
- Floor mounted
- Bolt together design

Dimensions:

- Length: 199cm
- Depth: 240cm
- Height: 101cm
- Weight: 240kg

Order Code

ZXP-RKHF-7230

Item Description

XP Wall Storage with Pull up bar - Single 72" Wide Station (Single x 2)





XP PERFORMANCE 4 TIER STORAGE RACK

Features:

- Horizontal style frame
- Baked powder coating
- 3mm thick oval tube steel
- Wheeled base for easy portability

Dimensions:

Width: 86cm
 Height: 122cm
 Depth: 79cm
 Weight: 60kg

ZIVA Expert Recommends with Functional Training Toolkit Set: 2 x Fitball 65cm, 3 x slam ball 5/10/15kg, 2 x foam roller, 2 x pads, 3 x wall ball 4/6/8kg, 3 x med ball 4/6/8kg, 4 x kettle bell 8/12/14/16kg, 4 x pair Hex 5/10/15/20

Order Code

ZXP-TBSR-6775
 ZXP-TBSR-4071

Item Description

XP Performance 4 Tier Storage Rack
 XP Performance 4 Tier Storage Rack + Performance Training Toolkit Set



MULTI-FUNCTIONAL STORAGE RACK

Features:

- Charcoal powder coated finish
- 3 mm thick steel
- Multi storage rack stores: hex dumbbells, kettlebells, wall balls, med balls, and bumper discs
- 75 x 75mm steel tube

Dimensions:

- Length: 187.2cm
- Depth: 85.5cm
- Height: 181.9cm
- Weight: 128kg

Order Code

ZXP-MFSR-7219

Item Description

Multi-Functional Storage Rack

JOHN BROOKFIELD

BATTLING ROPES CREATOR
AND MULTIPLE WORLD RECORD HOLDER

“

I am extremely excited to be joining forces with ZIVA. The leadership of ZIVA are the type of professionals I have been looking for in the health and fitness industry. They are professional and extremely passionate in every way. I look forward to working with them for a long time to come!!

”





SIGNATURE BATTLING ROPES

Designed to the specifications of John Brookfield, the famed master of strength feats who introduced rope training to the world, ZIVA Signature Battling Ropes are the best training ropes available. The Signature battle rope has been constructed using high quality, durable and hard wearing materials. This rope is designed to last. It comes with our comfortable handle design which allows serious training.

Features:

- Designed with John Brookfield
- Signature patented handle design reduces grip fatigue
- Available in four sizes

Order Code	Set Description
ZMT-BTRP-5610	Signature Battling Rope (5cm x 15.24 m) / (2.0" x 50') 16kg
ZMT-BTRP-5611	Signature Battling Rope (3.8cm x 10 m) / (1.5" x 33') 8kg
ZMT-BTRP-5612	Signature Battling Rope (3.8cm x 15.24 m) / (1.5" x 50') 12kg
ZMT-BTRP-5613	Signature Battling Rope (5.0cm x 10 m) / (2.0" x 33') 10.6kg



SIGNATURE POWERWAVE®

A busy lifestyle shouldn't be a reason to neglect health, Signature PowerWave® is a revolutionary cross-trainer that is guaranteed to unleash explosive core strength and physical endurance to achieve your desired shape, no matter what your age, ability or fitness level and offers a unique experience for effective and diverse 20-minute functional workouts.

Order Code	Set Description
ZMT-PWVE-6180	Signature PowerWave Apollo 4kg
ZMT-PWVE-6181	Signature PowerWave Super 7kg
ZMT-PWVE-6182	Signature PowerWave Spartan 12kg
ZMT-PWVE-6183	Signature PowerWave Beast 20kg



JAY LAVILLE

POWERWAVE® FOUNDER & CEO

“

Working with a brand like ZIVA allows PowerWave to expand our global audience at a far greater rate whilst maintaining our core values. The ZIVA team have not only kept our high grade quality amongst our product range but have also worked with us to keep brand consistency and services across the different market territories. I look forward to the launch and showcasing how our product can truly impact people's lives for the better.

”

“For Selfit, ZIVA’s great advantage, besides the high quality of the equipment, is the commitment to the partnership, to be together making it happen, believing in all our ideas and actively participating in building a better journey for our guests. Summed up in one sentence: Be more than a brand renowned for its quality...be participative in this construction of wellness.”

Karina Acioly
Director Supply Chain
Selfit
Brasil





VIPR by ZIVA

Features:

- Premium Super Tough Rubber Compound
- Solid indestructible designed allows it to be slammed, lifted, thrown or dragged for energy burning workouts.

Order Code	Item Description
ZVR-RBRP-04KG-YL	VIPR by ZIVA 4kg
ZVR-RBRP-06KG-LG	VIPR by ZIVA 6kg
ZVR-RBRP-08KG-DG	VIPR by ZIVA 8kg
ZVR-RBRP-10KG-BK	VIPR by ZIVA 10kg



VIPR by ZIVA RACK 3 TIER

Features:

- Compact design with minimal footprint
- Rubber cushioned steel shelf
- 3mm thick steel frame
- Black powder coated finish
- Non marking feet with option to bolt down
- Stores up to 30 VIPRS

Order Code	Item Description
ZVR-VPRK-1115	VIPR by ZIVA Rack 3 Tier



JANE WALLER

VIPR EXECUTIVE DIRECTOR /
FITNESS PROFESSIONALS LTD, UK

“

We've worked with David Barr and the team at ZIVA for almost 8 years on developing, manufacturing and now distributing our VIPR product. Our relationship is built around honesty and trust, and it's a pleasure doing business with David and the ZIVA team. They are efficient, professional and respectful. There's a reason why ZIVA is world renowned for it's manufacturing and distribution of functional fitness products. Simply, they are the best.

”



SL TYRE X

Features:

- Ranges in weight from 10kg to 80kg
- Long lasting reinforced PVC cover
- Reinforced gripping handles

Order Code	Item Description
ZSL-TYVR-4127	SL Tyre X 40kg
ZSL-TYVR-4128	SL Tyre X 60kg
ZSL-TYVR-4129	SL Tyre X 80kg
ZSL-TYVR-4139	SL Tyre X 10kg Pump



ZVO BALANCE BALL

Features:

- Designed to develop and enhance stability and coordination
- Made from durable long-lasting PVC cover
- Flat bottom made from hard wear PE
- Handle attachment points either side

Order Code	Item Description
ZVO-BUBL-0564	ZVO Balance Ball





ANTI-BURST CORE-FIT BALL

Features:

- 55, 65 or 75cm diameter
- Durable thick walls for hard use
- Anti-burst provides safe use

Order Code

Item Description

ZVO-ABCB-9291	ZIVA 55cm Anti-Burst Core-Fit Ball
ZVO-ABCB-9270	ZIVA 65cm Anti-Burst Core-Fit Ball
ZVO-ABCB-9292	ZIVA 75cm Anti-Burst Core-Fit Ball





SIGNATURE GLUTE PLYO BOX

The GLUTE plyo box can be used as standard plyobox but adds the possibility to perform a range of glute-focused exercises in a comfortable and effective way.

The lack of an optimal solution to implement these exercises force trainees to use existing equipment that has not been developed for that purpose compromising both user's safety and comfort.

Features:

- Exercise examples
- 75 x 75 base with sloping top

Order Code	Set Description
ZMT-GLPY-5671	Signature Glute Plyo Box



SL SOFT PLYO BOX 3 IN 1 WITH PU FOAM

Features:

- Space saving 3-in-1 design provides three different heights in one box
- Soft surfaced cushioned landing areas
- PU foam
- 51 x 61 x 75cm heights
- Same dimensions as plyo boxes used in Cross Fit Games



Order Code	Item Description
ZSL-SFPY-4013	SL Soft Plyo Box 3 in 1 with PU Foam (51cm x 61cm x 75cm)



ZVO DUAL SURFACE PLYO BOXES

Features:

- Boxes can be stacked on top of each other and are held in place securely with Velcro flaps
- Unique stackable design minimizes space required
- Light and easier to move around
- Dual Surface Plyo feature a single hard surface side and two non-slip surfaced sides
- Working platform area – 75 x 75cm

Order Code	Item Description
ZFT-PYST-0738	ZVO Dual Surface Plyo Box 3 Piece Set - 15, 30, and 45cm (6", 12", and 18" inches) New Velcro Strap
ZFT-PYST-0739	ZVO Dual Surface Plyo Box 4 Piece set - 15, 30, 45 and 60cm (6", 12", 18" and 24" inches) New Velcro Strap







ZVO COMPETITION COLORED BUMPER DISCS

Features:

- Precision casting
- Large hard chrome plated hubs (not on support discs)
- Premium urethane surface coating
- Beveled edges for easy pickup
- Bumper discs have 450mm outer diameter for 5 - 25kg (IWF standards)
- Competition color coding: 5kg = Black, 10kg = Green, 15kg = Yellow, 20kg = Blue, 25kg = Red

**Fractional support discs available upon request (0.5, 1, 1.5, 2 and 2.5kg discs)*

Order Code	Item Description
ZVO-BDPU-3702	ZVO Urethane Competition Colored Bumper Disc 5kg (80mm Hard Chrome Hub)
ZVO-BDPU-3703	ZVO Urethane Competition Colored BumperDisc 10kg (120mm Hard Chrome Hub)
ZVO-BDPU-3704	ZVO Urethane Competition Colored Bumper Disc 15kg (120mm Hard Chrome Hub)
ZVO-BDPU-3705	ZVO Urethane Competition Colored Bumper Disc 20kg (120mm Hard Chrome Hub)
ZVO-BDPU-3706	ZVO Urethane Competition Colored Bumper Disc 25kg (120mm Hard Chrome Hub)
ZVO-BDPU-3700	ZVO Urethane Fractional Discs (2x0.5kg, 2x1kg, 2x1.5kg, 2x2kg, 2x2.5kg)
ZVO-BDRB-3711	ZVO Rubber Competition Colored Training Bumper Disc 5kg (80mm Hard Chrome Hub)
ZVO-BDRB-3712	ZVO Rubber Competition Colored Training Bumper Disc 10kg (120mm Hard Chrome Hub)
ZVO-BDRB-3713	ZVO Rubber Competition Colored Training Bumper Disc 15kg (120mm Hard Chrome Hub)
ZVO-BDRB-3714	ZVO Rubber Competition Colored Training Bumper Disc 20kg (120mm Hard Chrome Hub)
ZVO-BDRB-3715	ZVO Rubber Competition Colored Training Bumper Disc 25kg (120mm Hard Chrome Hub)
ZVO-BDRB-3709	ZVO Rubber Fractional Discs (2x0.5kg, 2x1kg, 2x1.5kg, 2x2kg, 2x2.5kg)



ZVO URETHANE BLACK BUMPER DISCS

Features:

- Precision casting
- Large hard chrome plated hubs (not on support discs)
- Premium urethane surface coating
- Beveled edges for easy pickup
- Bumper discs have 450mm outer diameter for 5 - 25kg (IWF standards)
- Black disc with LOGO and NUMBER color coding
5kg = White, 10kg = Green, 15kg = Yellow, 20kg = Blue, 25kg = Red

Order Code	Item Description
ZVO-BDPU-3720	ZVO Urethane Black Bumper Disc 5kg (80mm Hard Chrome Hub)
ZVO-BDPU-3721	ZVO Urethane Black Bumper Disc 10kg (120mm Hard Chrome Hub)
ZVO-BDPU-3722	ZVO Urethane Black Bumper Disc 15kg (120mm Hard Chrome Hub)
ZVO-BDPU-3723	ZVO Urethane Black Bumper Disc 20kg (120mm Hard Chrome Hub)
ZVO-BDPU-3724	ZVO Urethane Black Bumper Disc 25kg (120mm Hard Chrome Hub)



XP COMPETITION COLORED RUBBER BUMPERS

Features:

- 450mm outer diameter (IWF Standards, 5 - 25kg)
- Solid stainless steel insert
- Precision casting
- Durable virgin rubber surface coating
- Competition color coding
5kg = Black, 10kg = Green, 15kg = Yellow, 20kg = Blue, 25kg = Red

Order Code	Item Description
ZXP-RBBP-7491	XP Competition Colored Rubber Bumper 5kg
ZXP-RBBP-7492	XP Competition Colored Rubber Bumper 10kg
ZXP-RBBP-7493	XP Competition Colored Rubber Bumper 15kg
ZXP-RBBP-7494	XP Competition Colored Rubber Bumper 20kg
ZXP-RBBP-7495	XP Competition Colored Rubber Bumper 25kg

XP RUBBER BLACK BUMPER DISKS

Features:

- 450mm outer diameter (IWF Standards, 5 - 25kg)
- Solid stainless steel insert
- Precision casting
- Durable virgin rubber surface coating
- Black disc with LOGO and NUMBER color coding
5kg = White, 10kg = Green, 15kg = Yellow, 20kg = Blue, 25kg = Red

Order Code	Item Description
ZXP-RBBP-7485	XP Rubber Black Bumper Disc 5kg
ZXP-RBBP-7486	XP Rubber Black Bumper Disc 10kg
ZXP-RBBP-7487	XP Rubber Black Bumper Disc 15kg
ZXP-RBBP-7488	XP Rubber Black Bumper Disc 20kg
ZXP-RBBP-7489	XP Rubber Black Bumper Disc 25kg



ZVO-HCOB-2988

ZVO-HCOB-2990

ZVO-HCOB-2991

ZVO-HCOB-2985

ZVO-HCOB-2989

ZVO PREMIUM OLYMPIC BARS

Features:

- Fits standard Olympic size discs
- Premium hard chrome coated 50mm sleeves
- Needle bearings for smooth and even rotation during lifts
- Capped ends for reduced maintenance
- Brass Bushing

Order Code	Item Description
ZVO-HCOB-2988	ZVO Men's 2.2m 230K PSI Premium Olympic Bar 2000LBS Tested - 28mm Weight: 20kgs - Silver Crossfit and Powerlifting Knurling
ZVO-HCOB-2990	ZVO Men's 2.2m 230K PSI Premium Olympic Bar 2000LBS Tested - 28mm Weight: 20kgs - Black Oxide Bar Crossfit and Powerlifting Knurling
ZVO-HCOB-2991	ZVO Women's 2.01m 230K PSI Premium Olympic Bar 1500LBS Tested - 25mm Weight: 15kgs - Silver Bar Crossfit and Powerlifting Knurling
ZVO-HCOB-2985	ZVO Women's 2.01m 230K PSI Premium Olympic Bar 1500LBS Tested - 25mm Weight: 15kgs - Black Bar Crossfit and Powerlifting Knurling
ZVO-HCOB-2989	ZVO Men's 1.7m 230K PSI Technical Bar 1000LBS Tested - 25mm Weight: 10kgs - Black Oxide bar & Silver Sleeves





OLYMPIC LIFTING PLATFORM

Features:

- 50mm x 25mm (2" x 1") steel frame
- Laser cut and precision bent gussets
- Bolt together design
- Rubber tiles
- Bamboo wood center
- Does not need to be bolted to the ground

Dimensions:

Width: 255.5cm
 Length: 320.5cm
 Weight: 183kg

Order Code	Item Description
ZXP-OLCR-8979	XP Olympic Lifting Platform



XP BUMPER STORAGE RACK

Features:

- Powder coated finish
- 3mm thick steel
- Built in handle and wheels for easy portability

Dimensions:

Length: 118cm
 Width: 40cm
 Weight: 12kg

Order Code	Item Description
ZXP-RGRK-0902	XP Bumper Storage Rack



ST2 10 PAIR 3-TIER HEXAGON DUMBBELL RACK

Features:

- 3 tier vertical style frame
- Baked powder coating
- 3mm thick round tube steel
- Flat shelving design without saddles
- Can hold XP Hex dumbbells or SL Hexagon Dumbbells
- Non marking feet with option to bolt down

Dimensions:

Width: 148cm
 Height: 91.9cm
 Depth: 54.1cm
 Weight: 38kg

Order Code	Item Description
ZST-DBST-5410	ST2 10 Pair 3-Tier Hexagon Dumbbell Rack (without saddle)

Frame Color Options:

Black or Silver



SL 1-10 HEXAGON DUMBBELL RACK

Features:

- Horizontal style frame
- Baked powder coating
- 3mm thick oval tube steel
- Flat shelving design without saddles
- Can hold XP Hex Dumbbells or SL Hexagon Dumbbells
- Small footprint

Dimensions:

Width: 78cm
 Height: 70.5cm
 Depth: 44.5cm

Order Code	Item Description
ZSL-DBST-5383	SL 1-10 Hexagon Dumbbell Rack



Frame Color Options:

Black or Silver



SL 10 PAIR HEXAGON DUMBBELL RACK

Features:

- Horizontal style frame
- Baked powder coating
- 3mm thick oval tube steel
- Flat shelving design without saddles
- Can hold XP Hex dumbbells or SL Hexagon Dumbbells
- Small footprint

Dimensions:

Width: 147cm
 Height: 70.5cm
 Depth: 44.5cm

Order Code	Item Description
ZSL-DBST-5386	SL 10 Pair Hexagon Dumbbell Rack



Frame Color Options:

Black or Silver





SL PREMIUM HEXAGON VIRGIN RUBBER DUMBBELLS

Features:

- Unique rounded hexagon design
- Knurled chrome grips (1 - 10kg = 29mm, 12 - 20kg = 33mm, and 22 - 50kg = 35mm diameter grips)
- Virgin rubber surface coating
- 1 - 10kg (1kg increments), 12 - 50kg (2kg increments)

Color Options:

Yellow / Grey / Red



Order Code

Item Description

ZSL-PRHD-6014	SL Premium Hexagon Virgin Rubber Dumbbell Set 1-10kg (10 Pairs)
ZSL-PRHD-6075	SL Premium Hexagon Virgin Rubber Dumbbell Set 2-20kg (10 Pairs)
ZSL-PRHD-6017	SL Premium Hexagon Virgin Rubber Dumbbell Set 12-20kg (5 pairs)
ZSL-PRHD-6018	SL Premium Hexagon Virgin Rubber Dumbbell Set 12-30kg (10 pairs)
ZSL-PRHD-6019	SL Premium Hexagon Virgin Rubber Dumbbell Set 22-30kg (5 pairs)
ZSL-PRHD-6020	SL Premium Hexagon Virgin Rubber Dumbbell Set 32-40kg (5 pairs)
ZSL-PRHD-6021	SL Premium Hexagon Virgin Rubber Dumbbell Set 42-50kg (5 pairs)



XP 2-TIER HEXAGON DUMBBELL RACK

Features:

- Horizontal style frame
- Baked powder coating
- 3mm thick oval tube steel
- Flat shelving design without saddles
- Can hold XP Hex Dumbbells or SL Hexagon Dumbbells
- Non marking feet with option to bolt down



Dimensions:

- Width: 241cm
- Height: 82cm
- Depth: 61cm

Order Code	Item Description
ZXP-DBST-5130	XP 2-Tier Hex Dumbbell Rack

XP 3-TIER HEXAGON DUMBBELL RACK

Features:

- 3 tier horizontal style frame
- Baked powder coating
- 3mm thick oval tube steel
- Flat shelving design without saddles
- Can hold XP Hex Dumbbells or SL Hexagon Dumbbells
- Non marking feet with option to bolt down



Dimensions:

- Width: 147cm
- Height: 98cm
- Depth: 74cm

Order Code	Item Description
ZXP-DBST-5131	XP 3-Tier Hex Dumbbell Rack



XP HEX DUMBBELLS

Features:

- Durable virgin rubber surface
- Cast heads
- Corrosion resistant chrome handle
- Anti-roll hex head shape
- Available in sizes 2.5 - 30kg (2.5 - 30kg in 2.5kg inc.)

Order Code	Item Description
ZXP-DBHX-6319	XP Hex Dumbbell Set (10 pairs) 1-10 kg, 110 kg
ZXP-DBHX-6320	XP Hex Dumbbell Set (10 pairs) 2.5 - 25kg, 275kg
ZXP-DBHX-6321	XP Hex Dumbbell Set (12 pairs) 2.5 - 30kg, 390kg
ZXP-DBHX-6322	XP Hex Dumbbell Set (20 pairs) 2.5 - 50kg, 1050kg
ZXP-DBHX-6323	XP Hex Dumbbell Set (10 pairs) 27.5 - 50kg, 775kg



STEVE COTTER

DIRECTOR OF IKFF

MEN'S HEALTH MAGAZINE TOP 100 FITTEST MEN OF ALL-TIME

“

When I first met the team at ZIVA, I was excited to be working with such a passionate, driven and forward-thinking company. ZIVA's history, purpose company values, and culture impressed me then and continues to inspire me. Our goals are perfectly aligned. ZIVA's innovative designs and superior craftsmanship fit my own standards for high-quality and attention to details.

I'm so excited to expand my global reach with the ZIVA Steve Cotter signature-line kettlebell joint venture, and look forward to continuing my work with ZIVA to bring customers more innovating, space-saving, and functional training equipment for many years to come!

”



SIGNATURE SPORT KETTLEBELLS BY STEVE COTTER

Steve Cotter, world renowned kettlebell authority and ZIVA, have teamed up to design and build the Signature Sport Kettlebell. Its center weighted (up to 16kg) design is unique to the fitness market

Features:

- Designed with kettlebell authority Steve Cotter
- Standard International competition dimensions
- Textured surface holds chalk better for extended performance
- 34mm diameter handle

Order Code

ZMT-CTKB-5659
ZMT-CTKB-5660
ZMT-CTKB-5620
ZMT-CTKB-5621
ZMT-CTKB-5622
ZMT-CTKB-5623
ZMT-CTKB-5624
ZMT-CTKB-5625
ZMT-CTKB-5626
ZMT-CTKB-5627
ZMT-CTKB-5628
ZMT-CTKB-5629
ZMT-CTKB-5630
ZMT-CTKB-5631
ZMT-CTKB-5633
ZMT-CTKB-5634
ZMT-CTKB-5637

Set Description

Signature Sport Kettlebell 4 kg
Signature Sport Kettlebell 6 kg
Signature Sport Kettlebell 8 kg
Signature Sport Kettlebell 10 kg
Signature Sport Kettlebell 12 kg
Signature Sport Kettlebell 14 kg
Signature Sport Kettlebell 16 kg
Signature Sport Kettlebell 18 kg
Signature Sport Kettlebell 20 kg
Signature Sport Kettlebell 22 kg
Signature Sport Kettlebell 24 kg
Signature Sport Kettlebell 26 kg
Signature Sport Kettlebell 28 kg
Signature Sport Kettlebell 30 kg
Signature Sport Kettlebell 32 kg
Signature Sport Kettlebell 34 kg
Signature Sport Kettlebell 36 kg



ZIVA Classic series available: 4kg - 36kg in Black / Yellow



ZIVA Competition colors series available: 4kg - 6kg in Black, 8kg - 10kg in Pink, 12kg - 14kg in Blue, 16kg - 18kg in Yellow, 20kg - 22kg Purple, 24kg - 26kg in Green, 28kg - 30kg in Orange, 32kg - 34kg in Red, 36kg in Grey



“ The ZIVA equipment range has been a great solution for the partnership between Les Mills and Emirates Team New Zealand. We wanted to create a versatile workout space that could easily adapt to different training modalities for the team, while also handling the unique individual strength and fitness requirements. ”

*Ish Cheyne
Head of Fitness
Les Mills
New Zealand*



ZVO URETHANE COMPETITION KETTLEBELLS

Features:

- Standard competition size: Height: 28cm, Bell diameter: 19cm (excluding 4kg and 6kg training kettlebells), Base diameter: 11cm
- Stainless steel handle (grip diameter: 34mm)
- (4 - 20kg = 2kg increments, 24 - 48kg = 4kg increments)

Competition insert colors:

4kg - black	12kg - blue	20kg - purple	36kg - grey
6kg - black	14kg - blue	24kg - green	40kg - white
8kg - pink	16kg - yellow	28kg - orange	44kg - silver
10kg - pink	18kg - yellow	32kg - red	48kg - gold

Order Code	Item Description
ZVO-KBPU-2401	ZVO Urethane Training Kettlebell 4kg
ZVO-KBPU-2402	ZVO Urethane Training Kettlebell 6kg
ZVO-KBPU-2403	ZVO Urethane Competition Kettlebell 8kg
ZVO-KBPU-2404	ZVO Urethane Competition Kettlebell 10kg
ZVO-KBPU-2405	ZVO Urethane Competition Kettlebell 12kg
ZVO-KBPU-2406	ZVO Urethane Competition Kettlebell 14kg
ZVO-KBPU-2407	ZVO Urethane Competition Kettlebell 16kg
ZVO-KBPU-2408	ZVO Urethane Competition Kettlebell 18kg
ZVO-KBPU-2409	ZVO Urethane Competition Kettlebell 20kg
ZVO-KBPU-2410	ZVO Urethane Competition Kettlebell 24kg
ZVO-KBPU-2411	ZVO Urethane Competition Kettlebell 28kg
ZVO-KBPU-2412	ZVO Urethane Competition Kettlebell 32kg
ZVO-KBPU-2413	ZVO Urethane Competition Kettlebell 36kg
ZVO-KBPU-2414	ZVO Urethane Competition Kettlebell 40kg
ZVO-KBPU-2415	ZVO Urethane Competition Kettlebell 44kg
ZVO-KBPU-2416	ZVO Urethane Competition Kettlebell 48kg

EX KETTLEBELL RACK

Features:

- Horizontal style frame
- Steel shelf
- Non marking feet with option to bolt down
- Black or brushed steel panel options
- Baked powder coating

Dimensions:

Width: 125cm
 Height: 75cm
 Depth: 55cm
 Weight: 55kg

Order Code	Item Description
ZEX-KB05-7003	EX Kettlebell Rack



XP KETTLEBELL RACK

Features:

- Compact design with minimal footprint
- Steel frame
- Floor mounted
- Laser cut and precision bent gussets

Dimensions:

Width: 35cm
 Height: 151.8cm
 Depth: 41cm
 Weight: 36kg

Order Code	Item Description
ZXP-KBRK-6004	XP Kettlebell Rack



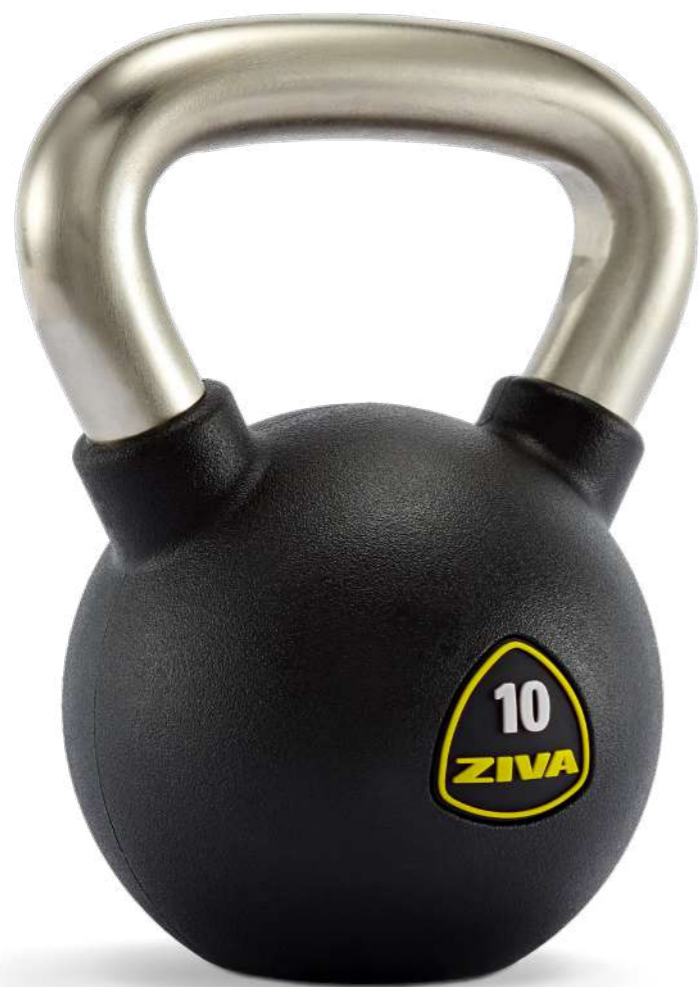

Color Options:
Yellow / Grey / Red



SL URETHANE KETTLEBELLS

Features:

- Solid cast steel
- Premium urethane finish
- 4 - 16kg in 2kg increments, 20 - 40kg in 4kg increments

Order Code	Item Description
ZSL-PUKB-9670	SL Urethane Kettlebell 4kg
ZSL-PUKB-9671	SL Urethane Kettlebell 6kg
ZSL-PUKB-9672	SL Urethane Kettlebell 8kg
ZSL-PUKB-9673	SL Urethane Kettlebell 10kg
ZSL-PUKB-9674	SL Urethane Kettlebell 12kg
ZSL-PUKB-9675	SL Urethane Kettlebell 14kg
ZSL-PUKB-9676	SL Urethane Kettlebell 16kg
ZSL-PUKB-9677	SL Urethane Kettlebell 20kg
ZSL-PUKB-9678	SL Urethane Kettlebell 24kg
ZSL-PUKB-9679	SL Urethane Kettlebell 28kg
ZSL-PUKB-9680	SL Urethane Kettlebell 32kg
ZSL-PUKB-9681	SL Urethane Kettlebell 36kg
ZSL-PUKB-9682	SL Urethane Kettlebell 40kg



SL VIRGIN RUBBER KETTLEBELLS

Features:

- Nickel coated handle
- Solid cast steel
- Durable virgin rubber finish
- 4 - 16kg in 2kg increments, 20 - 40kg in 4kg increments

Order Code	Item Description
ZSL-RBKB-4320	SL Virgin Rubber Kettlebell 4kg
ZSL-RBKB-4321	SL Virgin Rubber Kettlebell 6kg
ZSL-RBKB-4322	SL Virgin Rubber Kettlebell 8kg
ZSL-RBKB-4323	SL Virgin Rubber Kettlebell 10kg
ZSL-RBKB-4324	SL Virgin Rubber Kettlebell 12kg
ZSL-RBKB-4325	SL Virgin Rubber Kettlebell 14kg
ZSL-RBKB-4326	SL Virgin Rubber Kettlebell 16kg
ZSL-RBKB-4327	SL Virgin Rubber Kettlebell 20kg
ZSL-RBKB-4328	SL Virgin Rubber Kettlebell 24kg
ZSL-RBKB-4329	SL Virgin Rubber Kettlebell 28kg
ZSL-RBKB-4330	SL Virgin Rubber Kettlebell 32kg
ZSL-RBKB-4331	SL Virgin Rubber Kettlebell 36kg
ZSL-RBKB-4332	SL Virgin Rubber Kettlebell 40kg



ST2 KETTLEBELL RACK

Features:

- Compact design with minimal footprint
- Rubber cushioned steel shelf
- 3mm thick steel frame
- Powder coated finish
- Non marking feet with option to bolt down
- Stores up to 10 ZIVA kettlebells

Dimensions:

Width: 111cm
Height: 81.5cm
Depth: 66.5cm
Weight: 50kg

Order Code	Item Description
ZST-KBRK-5395	ST2 Kettlebell Rack

“The products delivered by ZIVA to Happy-fit are of best in class quality with outstanding designs and perform to the highest of standards. For many years I have ordered all my free weights and functional training products from ZIVA. With a perfect on time delivery record combined with excellent after-sales management my team and I are 100% satisfied with our partnership and look forward to working with them for many years to come.”

Sven Decker
CEO
Happy-Fit
Europe





ZVO SLAM BALLS

Features:

- Tough PVC shell
- Stores easily on ST 5 and 10 Multi-Ball Trees
- Sand-filled weighted center

Order Code	Item Description
ZVO-SPSB-6870	ZVO Slam Ball 2kg
ZVO-SPSB-6871	ZVO Slam Ball 3kg
ZVO-SPSB-6872	ZVO Slam Ball 4kg
ZVO-SPSB-6873	ZVO Slam Ball 5kg
ZVO-SPSB-6874	ZVO Slam Ball 6kg
ZVO-SPSB-6875	ZVO Slam Ball 7kg
ZVO-SPSB-6876	ZVO Slam Ball 8kg
ZVO-SPSB-6877	ZVO Slam Ball 9kg
ZVO-SPSB-6878	ZVO Slam Ball 10kg
ZVO-SPSB-6879	ZVO Slam Ball 12kg
ZVO-SPSB-6880	ZVO Slam Ball 15kg
ZVO-SPSB-6881	ZVO Slam Ball 18kg
ZVO-SPSB-6882	ZVO Slam Ball 20kg
ZVO-SPSB-6883	ZVO Slam Ball 25kg
ZVO-SPSB-6884	ZVO Slam Ball 30kg

Color Options:

Black / Yellow
Black / Grey



ZVO MEDICINE BALLS

Features:

- Dual textured surface for improved gripping action
- Stores easily on ST 5 and 10 Multi-Ball Trees
- Durable virgin rubber

Order Code	Item Description
ZVO-CMMB-9060	ZVO Medicine Ball 1kg
ZVO-CMMB-9061	ZVO Medicine Ball 2kg
ZVO-CMMB-9062	ZVO Medicine Ball 3kg
ZVO-CMMB-9063	ZVO Medicine Ball 4kg
ZVO-CMMB-9064	ZVO Medicine Ball 5kg
ZVO-CMMB-9065	ZVO Medicine Ball 6kg
ZVO-CMMB-9066	ZVO Medicine Ball 7kg
ZVO-CMMB-9067	ZVO Medicine Ball 8kg
ZVO-CMMB-9068	ZVO Medicine Ball 9kg
ZVO-CMMB-9069	ZVO Medicine Ball 10kg



Color Options:

Yellow / Grey / Red



ZVO DUAL GRIP MEDICINE BALLS

Features:

- Textured surface for improved gripping action
- Universal size for all weights
- Stores easily on ST 5 and 10 Multi-Ball Trees
- Ideal for exercises where gripping is essential
- Durable virgin rubber

Order Code	Item Description
ZVO-DGMB-9230	ZVO Dual Grip Medicine Ball 3kg
ZVO-DGMB-9231	ZVO Dual Grip Medicine Ball 4kg
ZVO-DGMB-9232	ZVO Dual Grip Medicine Ball 5kg
ZVO-DGMB-9233	ZVO Dual Grip Medicine Ball 6kg
ZVO-DGMB-9234	ZVO Dual Grip Medicine Ball 7kg
ZVO-DGMB-9235	ZVO Dual Grip Medicine Ball 8kg
ZVO-DGMB-9236	ZVO Dual Grip Medicine Ball 9kg
ZVO-DGMB-9237	ZVO Dual Grip Medicine Ball 10kg



Color Options:

Yellow / Grey / Red





ZVO PREMIUM WALL BALLS

Features:

- 350mm (14") diameter
- High quality industrial grade PU outer coating, reinforced with 4mm composite skin
- Soft non slip grip
- High tensile strength stitching thread
- Premium quality embroidered logo & numbers
- Easy to clean surface
- Sand and steel shot weighted filler protected by a fully enclosed rubber ball

Order Code	Item Description
ZVO-FTWB-6370	ZVO Premium Wall Ball 2kg
ZVO-FTWB-6371	ZVO Premium Wall Ball 3kg
ZVO-FTWB-6372	ZVO Premium Wall Ball 4kg
ZVO-FTWB-6373	ZVO Premium Wall Ball 5kg
ZVO-FTWB-6374	ZVO Premium Wall Ball 6kg
ZVO-FTWB-6375	ZVO Premium Wall Ball 7kg
ZVO-FTWB-6376	ZVO Premium Wall Ball 8kg
ZVO-FTWB-6377	ZVO Premium Wall Ball 9kg
ZVO-FTWB-6378	ZVO Premium Wall Ball 10kg
ZVO-FTWB-6379	ZVO Premium Wall Ball 12kg



New industrial grade skin and high tensile stitching thread

Color Options:

Yellow or Grey



ZVO PREMIUM POWER CORE BAG WITH ERGONOMIC HANDLE

Features:

- High quality industrial grade PU outer coating, reinforced with 4mm composite skin
- Soft non slip grip
- High tensile strength stitching thread
- Premium quality embroidered logo & numbers
- Easy to clean surface
- Heavy duty nylon straps with ergonomic handles
- Air hole end caps allow for air release when compressed
- Sand filler in a hard wearing, indestructable ball for even weight distribution
- 5 - 22.5kg (2.5kg increments) and 25 - 30kg (5kg increments)

Order Code	Item Description
ZVO-SPPB-6385	ZVO Premium Power Core Bag with Ergonomic Handle 5kg
ZVO-SPPB-6386	ZVO Premium Power Core Bag with Ergonomic Handle 7.5kg
ZVO-SPPB-6387	ZVO Premium Power Core Bag with Ergonomic Handle 10kg
ZVO-SPPB-6388	ZVO Premium Power Core Bag with Ergonomic Handle 12.5kg
ZVO-SPPB-6389	ZVO Premium Power Core Bag with Ergonomic Handle 15kg
ZVO-SPPB-6390	ZVO Premium Power Core Bag with Ergonomic Handle 17.5kg
ZVO-SPPB-6391	ZVO Premium Power Core Bag with Ergonomic Handle 20kg
ZVO-SPPB-6392	ZVO Premium Power Core Bag with Ergonomic Handle 22.5kg
ZVO-SPPB-6393	ZVO Premium Power Core Bag with Ergonomic Handle 25kg
ZVO-SPPB-6394	ZVO Premium Power Core Bag with Ergonomic Handle 30kg



Premium quality embroidery of logo and numbers

Color Options:

Yellow or Grey



ST 5 MULTI-BALL TREE

Features:

- Vertical style frame
- Stores up to 5 medicine balls or slam balls
- Powder coated finish
- Non-marking feet
- Minimal footprint

Dimensions:

Width: 56cm
 Height: 154cm
 Depth: 47cm
 Weight: 14kg

Order Code	Item Description
ZST-MDRK-6008	ST 5 Multi-Ball Tree



Frame Color Options:

Black or Silver



ST 10 MULTI-BALL TREE

Features:

- Vertical style frame
- Stores up to 10 medicine balls or slam balls
- Powder coated finish
- Non-marking feet
- Minimal footprint

Dimensions:

Width: 71cm
 Height: 154cm
 Depth: 47cm
 Weight: 18kg

Order Code	Item Description
ZST-MDRK-6009	ST 10 Multi-Ball Tree



Frame Color Options:

Black or Silver



XP 3 TIER BALL STORAGE RACK

Features:

- Stores medicine balls, slam balls, and wall balls
- Powder coated finish
- 3mm thick steel
- Wheeled base for easy portability

Dimensions:

• Width: 162cm
 • Height: 160cm
 • Depth: 55cm

ZIVA Expert recommends: 6 Slam balls, 5 Medicine Balls, 4 Wall Balls

Order Code	Item Description
ZXP-TBSR-7229	XP 3 Tier Ball Storage Rack



ST 5 PIECE FUNCTIONAL ACCESSORIES STORAGE RACK

Features:

- Powder coated finish
- Cushioned rubber feet
- Stores 5 wall balls or power core bags
- Compact design with minimal footprint

Dimensions:

Width: 48.3cm
 Height: 172.7cm
 Depth: 55.9cm
 Weight: 22.7kg

Frame Color Options:

Black or Silver



Order Code

ZST-FTRK-0105

Item Description

ST 5 Piece Functional Accessories Storage Rack



ST 10 PIECE FUNCTIONAL ACCESSORIES STORAGE RACK

Features:

- Powder coated finish
- Cushioned rubber feet
- Stores 10 wall balls or power core bags
- Compact design with minimal footprint

Dimensions:

Width: 48.7cm
 Height: 172.7cm
 Depth: 81.3cm
 Weight: 29.9kg

Frame Color Options:

Black or Silver



Order Code

ZST-FTRK-0210

Item Description

ST 10 Piece Functional Accessories Storage Rack



XP 8' SELF SUPPORTED MODULAR RIGS

Features:

- Laser cut with powder coated finish
- 3mm thick steel 3" x 3" (75 x 75mm) frame
- 24mm zinc coated hardware
- 4' Section x 6' Section
- Includes one pair of J-Cups for each 4' wide RIGS
- Includes flying dual height pull bars for each RIGS section



Dimensions:

Height: 243.8cm
Width: 426.7cm
Depth: 182.8cm
Weight: 280.3kg



XP Rigs Color Options:

Black roof / Charcoal frame
Red roof / Charcoal frame
Yellow roof / Charcoal frame



Order Code

ZXP-SSRG-0822

Item Description

XP 8' High Self Supported Modular Rig (14' Station)

XP 9' SELF SUPPORTED MODULAR RIGS

Features:

- Laser cut with powder coated finish
- 3mm thick steel 3" x 3" (75 x 75mm) frame
- 24mm zinc coated hardware
- 4' Section x 6' Section
- Includes one pair of J-Cups for each 4' wide RIGS
- Includes flying dual height pull bars for each RIGS section



Dimensions:

Height: 274.3cm
Width: 426.7cm
Depth: 182.8cm
Weight: 299.8kg



XP Rigs Color Options:

Black roof / Charcoal frame
Red roof / Charcoal frame
Yellow roof / Charcoal frame



Order Code

ZXP-SSRG-0922

Item Description

XP 9' High Self Supported Modular Rig (14' Station)

Dimensions:

Height: 243.8cm
Width: 609.7cm
Depth: 182.8cm
Weight: 364.5kg



Order Code

ZXP-SSRG-0823

Item Description

XP 8' High Self Supported Modular Rig (20' Station)

Dimensions:

Height: 274.3cm
Width: 609.7cm
Depth: 182.8cm
Weight: 388.9kg



Order Code

ZXP-SSRG-0923

Item Description

XP 9' High Self Supported Modular Rig (20' Station)

Dimensions:

Height: 243.8cm
Width: 731.5cm
Depth: 182.8cm
Weight: 438.9kg



Order Code

ZXP-SSRG-0824

Item Description

XP 8' High Self Supported Modular Rig (24' Station)

Dimensions:

Height: 274.3cm
Width: 731.5cm
Depth: 182.8cm
Weight: 468.2kg

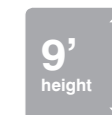

Order Code

ZXP-SSRG-0924

Item Description

XP 9' High Self Supported Modular Rig (24' Station)

XP 8' WALL-MOUNTED MODULAR RIGS

Features:

- Laser cut with powder coated finish
- 3mm thick steel 3" x 3" (75 x 75mm) frame
- 24mm zinc coated hardware
- 4' Section x 6' Section
- Includes one pair of J-Cups for each 4' wide RIGS
- Includes flying dual height pull bars for each RIGS section



Dimensions:

Height: 243.8cm
Width: 426.7cm
Depth: 121.9cm
Weight: 155.1kg



XP Rigs Color Options:

Black roof / Charcoal frame
Red roof / Charcoal frame
Yellow roof / Charcoal frame



Order Code

ZXP-WMRG-0827

Item Description

XP 8' High Wall-Mounted Modular Rig (14' Station)

XP 9' WALL-MOUNTED MODULAR RIGS

Features:

- Laser cut with powder coated finish
- 3mm thick steel 3" x 3" (75 x 75mm) frame
- 24mm zinc coated hardware
- 4' Section x 6' Section
- Includes one pair of J-Cups for each 4' wide RIGS
- Includes flying dual height pull bars for each RIGS section



Dimensions:

Height: 274.3cm
Width: 426.7cm
Depth: 121.9cm
Weight: 164.8kg



XP Rigs Color Options:

Black roof / Charcoal frame
Red roof / Charcoal frame
Yellow roof / Charcoal frame



Order Code

ZXP-WMRG-0927

Item Description

XP 9' High Wall-Mounted Modular Rig (14' Station)

Dimensions:

Height: 243.8cm
Width: 609.7cm
Depth: 121.9cm
Weight: 201.2kg



Order Code

ZXP-WMRG-0828

Item Description

XP 8' High Wall-Mounted Modular Rig (20' Station)

Dimensions:

Height: 274.3cm
Width: 609.7cm
Depth: 121.9cm
Weight: 213.4kg



Order Code

ZXP-WMRG-0928

Item Description

XP 9' High Wall-Mounted Modular Rig (20' Station)

Dimensions:

Height: 243.8cm
Width: 731.5cm
Depth: 121.9cm
Weight: 241.6kg



Order Code

ZXP-WMRG-0829

Item Description

XP 8' High Wall-Mounted Modular Rig (24' Station)

Dimensions:

Height: 274.3cm
Width: 731.5cm
Depth: 121.9cm
Weight: 256.3kg



Order Code

ZXP-WMRG-0929

Item Description

XP 9' High Wall-Mounted Modular Rig (24' Station)



XP SPACE SAVING MODULAR RIG

Features:

- 4 pairs of J-Cups
- 2 Flying double pull-up bars
- 4 pairs of safety arms
- 1 Landmine

Dimensions:

Width: 245cm
 Height: 360cm
 Depth: 100cm
 Weight: 352kg

XP Rigs Color Options:

- Black roof / Charcoal frame
- Red roof / Charcoal frame
- Yellow roof / Charcoal frame



Order Code

ZXP-SSRG-0831

Item Description

XP Space Saving Modular Rig

* Olympic bars sold separately

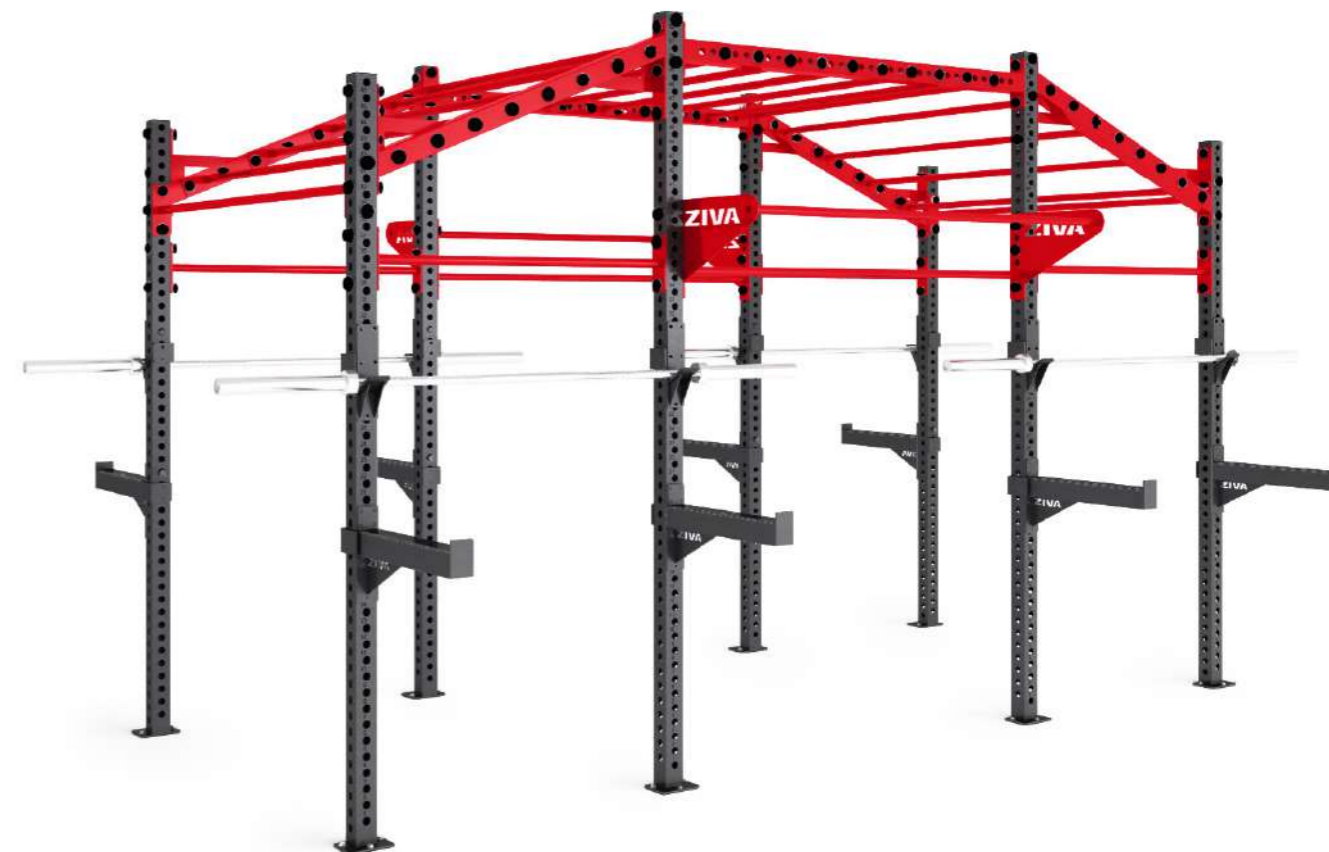

XP MULTI-TIERED MODULAR RIG

Features:

- Monkey bar system through the entire roof structure
- 4 pairs of J-Cups
- 2 Flying double pull-up bars
- 4 pairs of safety arms
- 4 single pull-up bars

Dimensions:

Width: 245cm
 Height: 427cm
 Depth: 183cm
 Weight: 403kg

XP Rigs Color Options:

- Black roof / Charcoal frame
- Red roof / Charcoal frame
- Yellow roof / Charcoal frame



Order Code

ZXP-SSRG-0836

Item Description

XP Multi-tiered Modular Rig

* Olympic bars sold separately



XP MODULAR RIG

Features:

- 4 pairs of J-Cups
- 4 pairs of safety arms
- Swedish flying pull-up attachment
- 1 Landmine

Dimensions:

Width: 245cm
 Height: 400cm
 Depth: 160cm
 Weight: 340kg

XP Rigs Color Options:

- Black roof / Charcoal frame
- Red roof / Charcoal frame
- Yellow roof / Charcoal frame



Order Code	Item Description
ZXP-SSRG-0837	XP Modular Rig

* Olympic bars sold separately



XP SPACE SAVING RACK AND STORAGE RIG

Features:

- 2 pairs of J-Cups
- 2 pairs of safety arms
- 2 flying pulls
- 2 Kettlebell/dumbbell storage shelves
- 1 Bumper storage shelf
- 8 Bumper pegs

Dimensions:

Width: 245cm
 Height: 400cm
 Depth: 160cm
 Weight: 515kg

XP Rigs Color Options:

- Black roof / Charcoal frame
- Red roof / Charcoal frame
- Yellow roof / Charcoal frame



Order Code	Item Description
ZXP-SSRG-0899	XP Space Saving Rack and Storage Rig

* Olympic bars sold separately

XP RIGS ATTACHMENTS



Order Code

ZXP-RGAT-0986
 ZXP-RGAT-0991
 ZXP-RGAT-0987
 ZXP-RGAT-0993
 ZXP-RGAT-0973
 ZXP-RGAT-0937
 ZXP-RGAT-0938
 ZXP-RGAT-0768
 ZPX-RGAT-0971
 ZXP-RGAT-0994
 ZXP-RGAT-0979
 ZXP-RGAT-0984
 ZXP-RGAT-0995
 ZXP-RGAT-0961
 ZXP-RGAT-0996
 ZXP-RGAT-0957

Item Description

① XP Ball Target Attachment
 ② XP Pull-Up Ball Attachment
 ③ XP D-Handle Attachment
 ④ XP J-Cup Attachment
 ⑤ XP Sandwich J-Cup Attachment
 ⑥ XP Core-Fit Ball Storage Shelf 42"
 ⑦ XP Core-Fit Ball Storage Shelf 72"
 ⑧ 42" Kettlebell/Dumbbell Storage Shelf
 ⑨ 72" Kettlebell/Dumbbell Storage Shelf
 ⑩ XP Safety Arms Attachment
 ⑪ XP Battle Rope Storage Attachment
 ⑫ Landmine Attachment
 ⑬ XP Chrome Plate Storage Peg Attachment
 ⑭ XP Stainless Steel Plate Storage Peg Attachment
 ⑮ Frame Mount Single Bar Storage Attachment
 ⑯ Roof Mount Olympic Bar Storage

Multigrip cross bars, flying pull up bars and dip station attachment available on request.



XP FARMERS WALK HANDLES

Features:

- Charcoal powder coated finish
- 32mm grip diameter
- 3mm thick steel

Dimensions:

- Length: 180cm
- Weight: 12kg

Order Code	Item Description
ZXP-RGRK-0916	XP Farmers Walk Handles

OLYMPIC BAR LANDING PADS

Features:

- Pads designed to absorb loaded Olympic bars dropped from height
- Air release ports
- Noise reduction for upper floor gyms

Order Code	Item Description
ZFT-OBLP-7843	Olympic Bar Landing Pads



PRO FT BALANCE PAD

Features:

- TPE material
- Available in black

Order Code	Item Description
ZFT-FPST-0190	PRO FT Balance Pad



WALL BALL & SLAM BALL LANDING PAD

Features:

- Pads designed to absorb noise from thrown balls to the floor from height
- Air release ports
- Noise reduction for upper floor gyms

Order Code	Item Description
ZFT-BLLP-7844	Wall Ball & Slam Ball Landing Pad

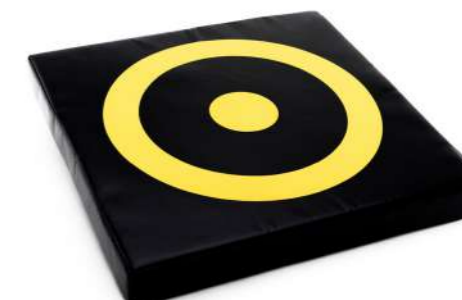

XP POWER SLED INCL HARNESS

Features:

- Charcoal powder coated finish
- Includes harness
- 3mm thick steel

Dimensions:

- Length: 101cm
- Width: 61cm
- Weight: 39kg

Order Code	Item Description
ZXP-PWSD-7231	XP Power Sled incl Harness



XP BATTLE ROPE

Features:

- Protective sleeve prevents fraying
- 5 and 3.8cm diameter
- 10 and 15m length

Order Code	Item Description
ZXP-BTRP-0912-BK	XP Battle Rope (5cm*15m)
ZXP-BTRP-0913-BK	XP Battle Rope (3.8cm * 10m)
ZXP-BTRP-0914-BK	XP Battle Rope (3.8cm * 15m)
ZXP-BTRP-0915-BK	XP Battle Rope (5.0cm * 10m)



GROUP X

ZIVA weights, storage, and accessories specially curated for group and class exercise environments and events. Training tools to help facilitate and optimize multi-person simultaneously executed exercise.

SIGNATURE  PRO•FT



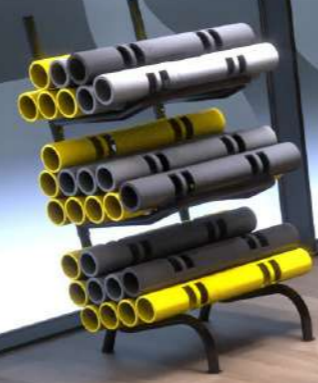



FITBENCH

TYLER DANEN

FOUNDER AND CEO OF FITBENCH®

“

When I first met the leadership team at ZIVA, I was excited to be working with such passionate and driven people. ZIVA's history, company values, and culture impressed me, and aligned perfectly with our team at FITBENCH. With ZIVA's innovative designs and superior craftsmanship, it was a natural partnership from the start. We are so excited to grow our global reach with the ZIVA FITBENCH joint venture, and we look forward to working with ZIVA to bring customers innovating, space saving, and functional equipment for years to come!

”



SIGNATURE FITBENCH

Order Code

ZMT-FTBH-6605
ZMT-FTBH-6603

Set Description

Signature Fitbench
Signature Fitbench with Rubber Accessories
- XP Rubber Hex Dumbbell 2 x 2kg, 2 x 4kg, 2 x 6kg, 2 x 10kg, 2 x 12.5kg, 2 x 15kg
- SL Rubber Kettlebell 1 x 8kg, 1 x 16kg
- ZVO Slam Ball 1 x 7kg
- XP Pro Latex Band Set x 2 (each set has 4 bands)





SIGNATURE POWERWAVE®

A busy lifestyle shouldn't be a reason to neglect health, Ziva PowerWave® is a revolutionary cross-trainer that is guaranteed to unleash explosive core strength and physical endurance to achieve your desired shape, no matter what your age, ability or fitness level and offers a unique experience for effective and diverse 20-minute functional workouts.

Order Code

ZMT-PWVE-6190
ZMT-PWVE-6191

Set Description

Signature PowerWave Group Exercise 15 Pieces Set (12 x 7kg, 3 x 12kg)
Signature PowerWave Training Exercise 6 Pieces Set (3 x 7kg, 2 x 12kg, 1 x 20kg)



VIPR by ZIVA SET

Features:

- Premium super tough rubber compound
- Solid indestructible designed allows it to be slammed, lifted, thrown or dragged for energy burning workouts

Order Code

ZVR-VPST-1118
ZVR-VPST-1119

Item Description

VIPR by ZIVA GROUP X 10 Pieces Set (6 x 4kg, 3 x 6kg, 1 x 8kg)
VIPR by ZIVA Personal Trainer 10 Pieces Set (3 x 4kg, 3 x 6kg, 2 x 8kg, 2 x 10kg)



PRO FT STEP

Features:

- Hard wearing PP casing
- Non slip landing pad
- Multi-height
- Stackable

Order Code

ZFT-FTSP-0593

Item Description

PRO FT Step

ST 10 SET STUDIO BARBELL RACK

Features:

- Round tube steel
- Stores discs, bars and collars
- Fits HX and standard style studio discs∞
- Baked powder coating
- Non marking feet with option to bolt down
- Storage for 10 barbell sets
- Rolling casters available separately
- Minimal footprint



Shown with casters

Dimensions:

Width: 73.7cm
 Height: 137.2cm
 Depth: 53.3cm
 Weight: 25kg

Order Code	Item Description
ZST-SB10-6005	ST 10 Set Studio Barbell Rack
ZST-SB10-6005B-KIT	ST Studio Barbell Rack Casters Kit (NO Rack)

Frame Color Options:

Black or Silver



ZVO HX STUDIO DISK SETS

Features:

- Precision solid cast core
- No-roll shape
- Hand grips for quick disc changes
- Premium urethane surface



* HX Premium Studio Barbell Sets feature 1.25kg, 2.5kg, 5kg (pairs) discs and one chrome studio bar and quick release collars (pairs)

Order Code	Item Description
ZVO-PHBS-1627	ZVO Urethane HX Studio Barbell Set w/ Chrome Studio Bar & Clamp Collar
ZVO-RHBS-2631	ZVO Rubber HX Studio Barbell Set w/ Chrome Studio Bar & Clamp Collar
ZVO-STCL-0438	Studio Monster Clamp Collar

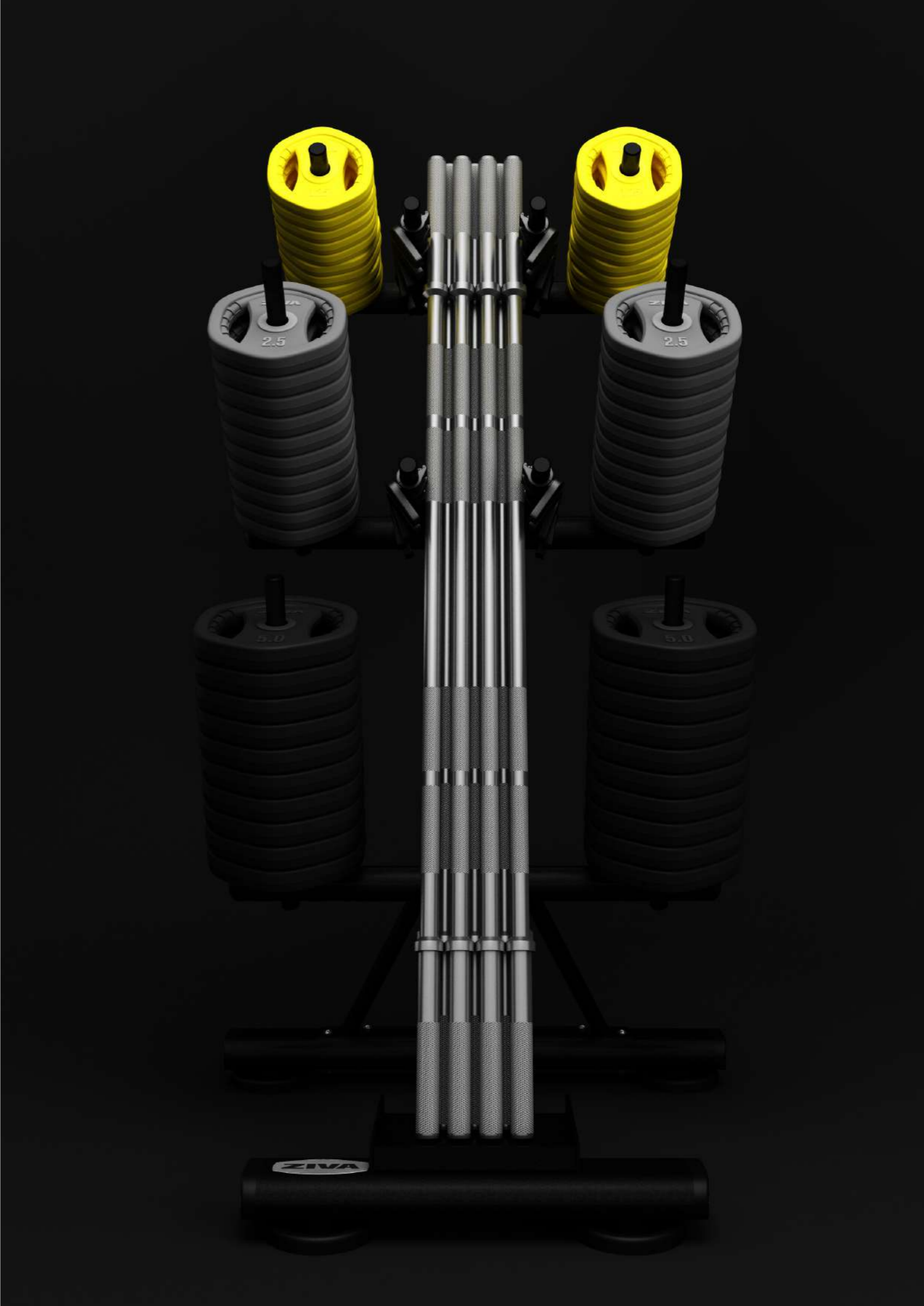

TPE DELUXE YOGA MAT

Features:

- Latex free TPE foam
- Patterned surface provides secure traction
- Closed cell construction prevents absorption of liquids
- Eyelets for easy storage
- Available in black
- 10mm or 14mm thickness



Order Code	Item Description
ZSL-TDYM-0250	TPE Deluxe Yoga Mat 125cm x 61cm x 14mm
ZSL-TDYM-0251	TPE Deluxe Yoga Mat 165cm x 61cm x 10mm

STUDIO NBR MAT

Features:

- Thick cushioned NBR (Studio Mat) with a soft airy feel, or TPE (Yoga Mat)
- Easy to clean hygienic surface
- Available in black
- 15mm thickness (Studio Mat)



Not suitable for polished surfaces

Order Code	Item Description
ZSL-NPSM-0204	Studio NBR Mat 165cm x 61cm x 15mm

STUDIO MAT RACK

Features:

- Space saving wall-mounted
- Stainless steel construction

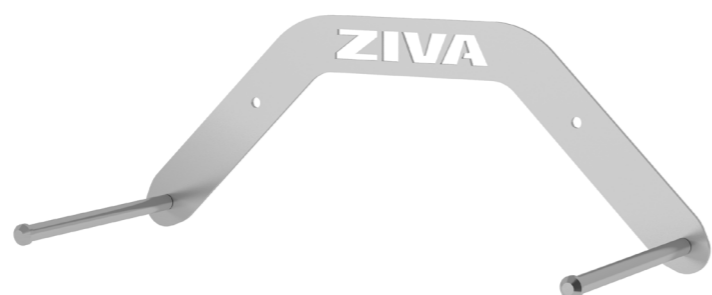

Order Code	Item Description
ZVO-MTRK-0200	Studio Mat Rack

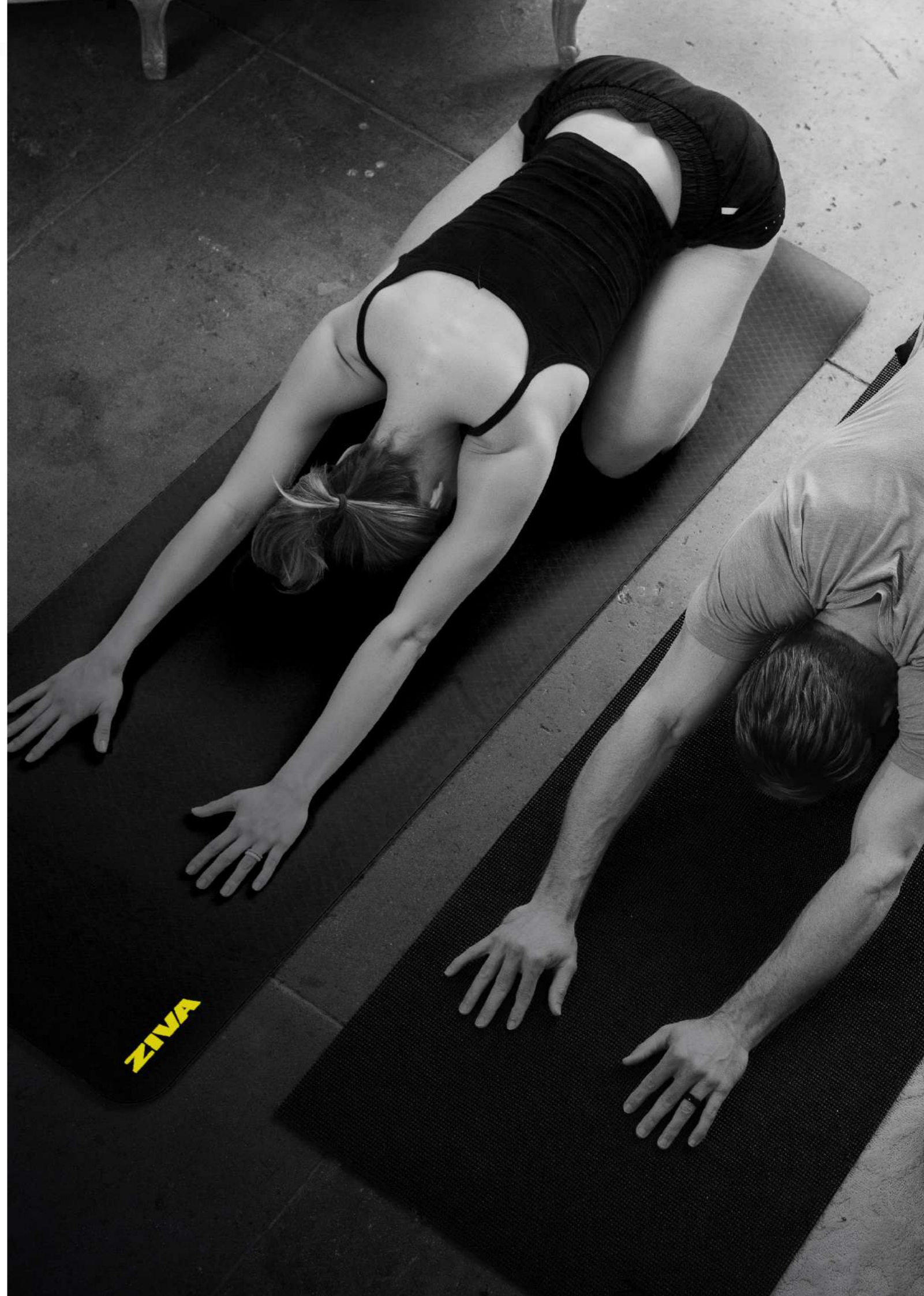

CUSTOMIZATION

The best of all worlds. Your legendary logo and color scheme with our unparalleled construction and build quality. Commercial grade premium materials to withstand the vigors of serious training. Custom logos and colors that make you feel at home, whether “home” is a corporate facility, a sports team, or anything else you’d like to represent while getting your work on.



ZIVA CUSTOMIZATION - FREE WEIGHTS

At ZIVA we understand the importance design and style can bring to your gym's aesthetics. By utilizing your branding and colors, we can help enhance your free weight area. We have created the opportunity for you to customize your dumbbells, barbells, EZ curls bars, kettlebells and bumper plates.

01 CHOOSE YOUR PRODUCT

Contact customer service for more details on MOQ, lead times and availability.

GRIP DISKS



KETTLEBELLS



DUMBBELLS



BUMPERS



BARBELLS



02 SELECT BASE COLOR

Choose any color of your choice. All options available.



03 APPLY YOUR LOGO





ZVO CUSTOMIZED URETHANE GRIP DISCS

Features:

- Solid stainless steel insert
- Precision casting
- Premium urethane surface coating
- Available in black base or custom color, customized logos and weight indicators

Order Code

ZVO-CCPU-3864
 ZVO-CCPU-3865
 ZVO-CCPU-3866
 ZVO-CCPU-3867
 ZVO-CCPU-3868
 ZVO-CCPU-3869
 ZVO-CCPU-3870

Item Description

ZVO Customized Urethane Grip Disc 1.25kg
 ZVO Customized Urethane Grip Disc 2.5kg
 ZVO Customized Urethane Grip Disc 5kg
 ZVO Customized Urethane Grip Disc 10kg
 ZVO Customized Urethane Grip Disc 15kg
 ZVO Customized Urethane Grip Disc 20kg
 ZVO Customized Urethane Grip Disc 25kg



ZVO CUSTOMIZED URETHANE DUMBBELLS

Features:

- Solid steel heads
- Premium urethane surface
- Stainless steel ring at joint
- Available in black base or custom color, customized logos and weight indicators
- 2 - 60kg (2kg increments) and 2.5 - 60kg (2.5kg increments)
- Ultra durable hard chrome plated grips
(1 - 10kg = 29mm, 12 - 20kg = 33mm, and 22 - 60kg are 35mm diameter grips)
(2.5 - 10kg = 29mm, 12.5 - 20kg = 33mm, 22.5 - 60kg = 35mm diameter handle)

Order Code

ZVO-CDPU-3161
ZVO-CDPU-3162
ZVO-CDPU-3163
ZVO-CDPU-3164
ZVO-CDPU-3165
ZVO-CDPU-3166

ZVO-CDPU-3350
ZVO-CDPU-3351
ZVO-CDPU-3361
ZVO-CDPU-3362

Item Description

ZVO Customized Urethane Dumbbell Set 2 - 20kg (10 pairs), 220kg
ZVO Customized Urethane Dumbbell Set 12 - 30kg (10 pairs), 420kg
ZVO Customized Urethane Dumbbell Set 22 - 30kg (5 pairs), 260kg
ZVO Customized Urethane Dumbbell Set 32 - 40kg (5 pairs), 360kg
ZVO Customized Urethane Dumbbell Set 42 - 50kg (5 pairs), 460kg
ZVO Customized Urethane Dumbbell Set 52 - 60kg (5 pairs), 560kg

ZVO Customized Urethane Dumbbell Set 2.5-25kg (10 pairs)
ZVO Customized Urethane Dumbbell Set 2.5-37.5kg (15 pairs)
ZVO Customized Urethane Dumbbell Set 27.5-37.5kg (5 pairs)
ZVO Customized Urethane Dumbbell Set 40-50kg (5 pairs)



ZVO CUSTOMIZED URETHANE BARBELLS AND EZ CURL BARBELLS

Features:

- Solid steel heads
- Premium urethane surface
- Color urethane end caps
- 10 - 20kg in 2.5kg, 25 - 45kg in 5kg increments
- Ultra durable hard chrome plated grips in 32mm (10 - 20kg) and 34mm (25 - 45kg) diameter grips
- Available in black base or custom color, customized logos and weight indicators

Order Code

ZVO-CBPU-4040
 ZVO-CBPU-4041
 ZVO-CBPU-4042

ZVO-CZPU-4055
 ZVO-CZPU-4056
 ZVO-CZPU-4057

Item Description

ZVO Customized Urethane Barbell Set 10 - 20kg (5 pieces), 75kg
 ZVO Customized Urethane Barbell Set 25 - 45kg (5 pieces), 175kg
 ZVO Customized Urethane Barbell Set 10 - 45kg (10 pieces), 250kg

ZVO Customized Urethane EZ Curl Barbell Set 10 - 20kg (5 pieces), 75kg
 ZVO Customized Urethane EZ Curl Barbell Set 25 - 45kg (5 pieces), 175kg
 ZVO Customized Urethane EZ Curl Barbell Set 10 - 45kg (10 pieces), 250kg



ZVO CUSTOMIZED URETHANE COMPETITION KETTLEBELLS

Features:

- Standard competition size: Height: 28cm, Bell diameter: 19cm (excluding 4kg and 6kg training kettlebells), Base diameter: 11cm
- Stainless steel handle (grip diameter: 34mm)
- (4 - 20kg= 2kg increments, 24 - 48kg= 4kg increments)
- Available in black base or custom color, customized logos and weight indicators

Order Code	Item Description
ZVO-CKPU-3871	ZVO Customized Urethane Competition Kettlebell Set 8-36kg (8 pieces, by 4kg)



ZVO CUSTOMIZED URETHANE BUMPERS

Features:

- Precision casting
- Large hard chrome plated hubs (not on support discs)
- Premium urethane surface coating
- Beveled edges for easy pickup
- Bumper discs have 450mm outer diameter for 5 - 25kg (IWF standards)
- Available in competition colors or customized colors
- Available in black base or custom color, customized logos and weight indicators

Order Code	Item Description
ZVO-CPPU-3730	ZVO Customized Urethane Bumper Disc 5kg (80mm Hard Chrome Hub)
ZVO-CPPU-3731	ZVO Customized Urethane Bumper Disc 10kg (120mm Hard Chrome Hub)
ZVO-CPPU-3732	ZVO Customized Urethane Bumper Disc 15kg (120mm Hard Chrome Hub)
ZVO-CPPU-3733	ZVO Customized Urethane Bumper Disc 20kg (120mm Hard Chrome Hub)
ZVO-CPPU-3734	ZVO Customized Urethane Bumper Disc 25kg (120mm Hard Chrome Hub)

XP CUSTOMIZED RIGS

When it comes to building a rig system for your gym, we have found it is all very customized. Space available is always different and your requirements are specific to fit your gym concept.

At ZIVA we realize this and have our customized rigs development system for you to build what you want.

Here are the questions you need to answer before contacting us:

1. What space do you want the rig in?
2. Is it wall mounted or free standing?
3. Is it accessible from a single side or double side?
4. What accessories do you want to add: landmine, D handle, flying pull up bars, etc.?

We are here to help you realise your concept.

01 CHOOSE YOUR PRODUCT

Start with the basic width and depth needed i.e. 14' wide with a depth of 4', wall mounted or free standing.



Free Standing Rig

Wall Mounted Rig

02 SELECT ACCESSORIES

Choose from monkey bars, flying pull up bars, accessory storage, plate storage and more.



03 ADD ADDITIONAL ACCESSORIES

Choose from smaller accessories such as D Handles for battle ropes, landmine attachments, dip bars and more.



04 SELECT YOUR COLOR

Main frames come standardized with black or charcoal color. Customized colors on roof available.

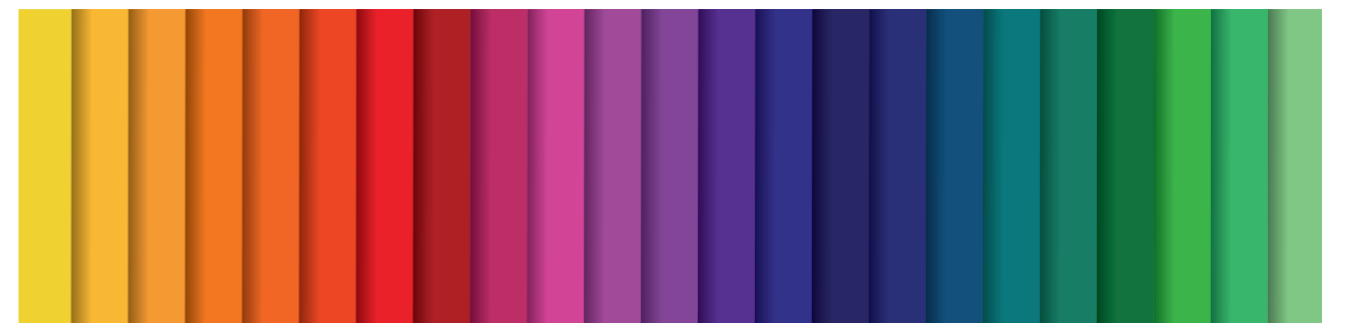



ZIVA

ZIVA

ZIVA

ZIVA

55

65

20

30

20

30

24

ZIVA



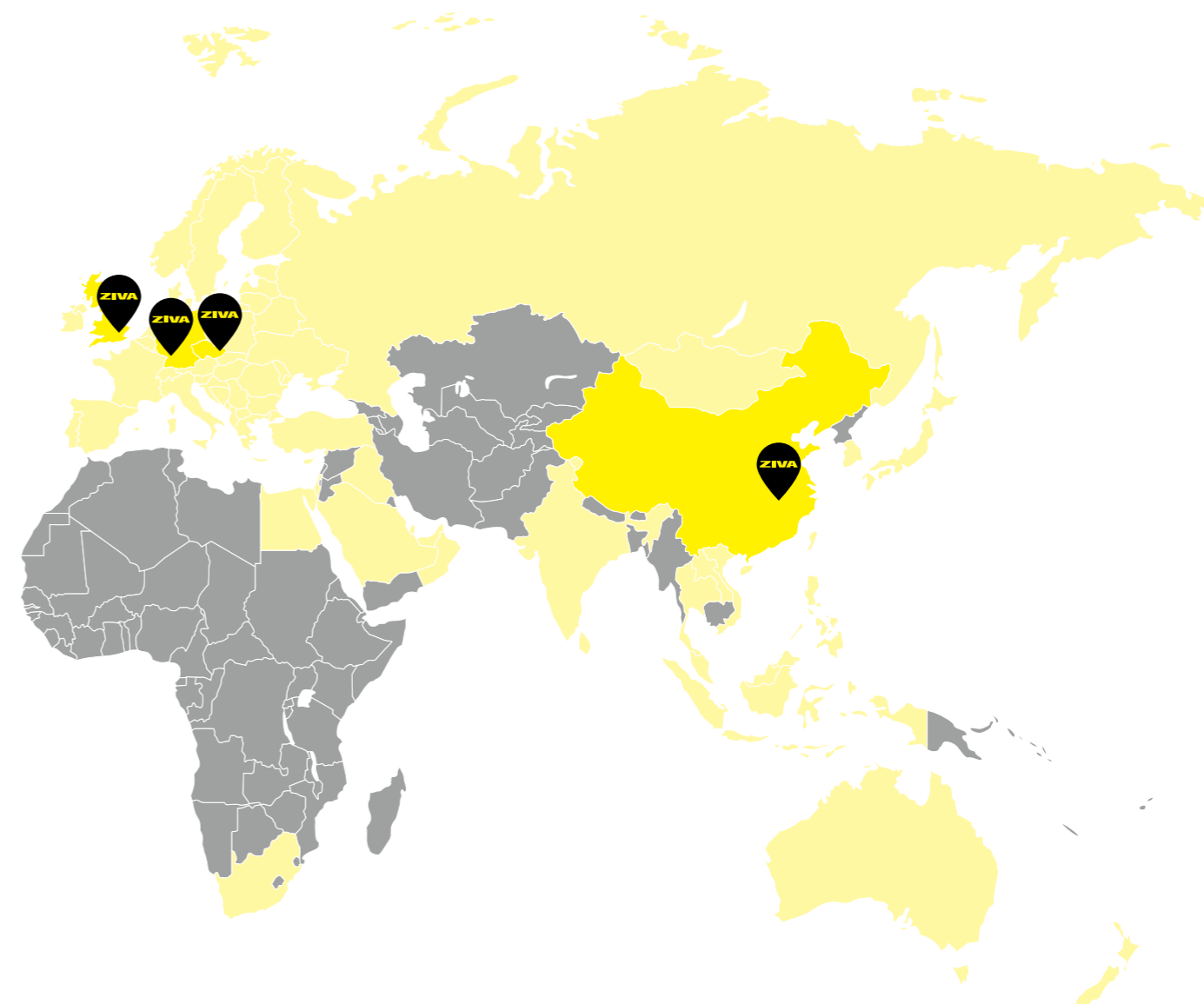
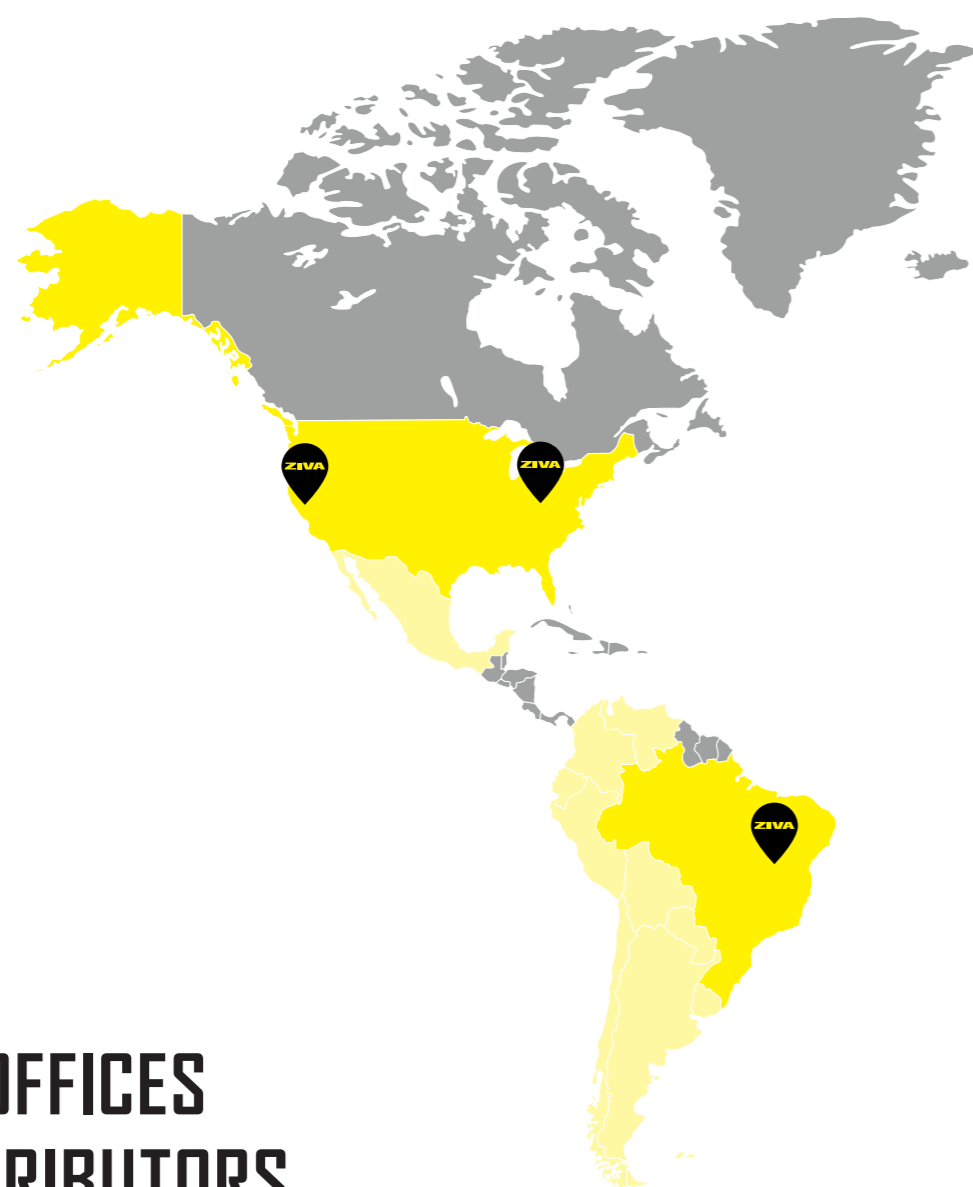

GLOBAL OFFICES AND DISTRIBUTORS FOOTPRINT

ZIVA USA LTD.

1685 Woodland Ave.
Columbus, OH 43219
USA

+1 (614) 379 3388
order@zivalife.com

ZIVA L.A. Studio

1200 S Hope St #302
Los Angeles, CA 90015
USA

+1 (323) 391-6100
content@zivalife.com

ZIVA Brazil

Juscelino Kubitschek
de Oliveira,
365-BR-277 - Conjunto
Plásticos do Paraná,
CIC Curitiba, Paraná
82305-200 BRAZIL

+55 41 3024 3725
sac@ZIVALife.com.br

ZIVA Europe s.r.o.

Vinohradská 365/10
120 00 Praha 2
CZECH REPUBLIC

+420 776 057 207
info@ziva-fitness.com

ZIVA Fitness UK LTD.

Kalbarri House 107-109
LONDON ROAD London,
ENGLAND E13 0DA

+44 (0) 20 8586 0101
sales@zivafitness.co.uk

ZIVA Fitness Europe GmbH

Max-Planck-Str. 7
59423 Unna
GERMANY

0800 49 44 49 44
info@ziva-europe.com

ZIVA (Shanghai) Co., Limited

2F, Block C, No.98
Yan Ping Road Shanghai,
200042 CHINA

+86 21 62460091
sales@zivalife.com

WARRANTY

ZIVA produces quality strength and fitness equipment. We do our utmost to ensure all products that leave our production facility are free of material defects and poor workmanship. ZIVA will repair or replace any products under warranty that can be shown to have broken or been damaged because of poor workmanship

INFINITY X

Infinity X Wall	Limited 5 year warranty on frames and welding; Plastic parts limited 1 year warranty*
Infinity X Tower	Limited 5 year warranty on frames and welding; Plastic parts limited 1 year warranty*
Infinity X Corner	Limited 5 year warranty on frames and welding; Plastic parts limited 1 year warranty*
Infinity X Accessories	Limited 1 year warranty*

STRENGTH

ZVO Free Weights	Limited 5 year on Urethane; Limited 2 year warranty on rubber warranty*
EX Racks	Limited 5 year warranty on frames and welding* Rubber & plastic parts 1 year warranty*
SL Free Weights	Limited 3 years on Urethane; Limited 2 year warranty on rubber warranty*
XP Free Weights	Limited 2 year warranty on Urethane; Limited 1 year warranty on rubber warranty*
ST2 Racks	Limited 5 year warranty on frames and welding* Rubber & plastic parts 1 year warranty*
ZVO Olympic Bars	Limited lifetime warranty*
EX Power Racks	Limited 5 year warranty on frames and welding* Rubber & plastic parts 1 year;
EX Platforms	Limited 1 year warranty*
XP Power Racks	Limited 5 year warranty on frames and welding* Rubber & plastic parts 1 year*
EX Benches	Limited 5 year warranty on frames and welding* Rubber & plastic parts 1 year*
ST2 Benches	Limited 5 year warranty on frames and welding* Rubber & plastic parts 1 year*

PERFORMANCE

EX Training Stations	Limited 5 year warranty on frames and welding* Rubber & plastic parts 1 year warranty*
XP Modular Training Stations	Limited 5 year warranty on frames and welding* Rubber & plastic parts 1 year warranty*
XP Storage	Limited 5 year warranty on frames and welding* Rubber & plastic parts 1 year warranty*
Signature Battle Rope	Limited 2 year warranty*
Signature PowerWave	Limited 2 year warranty*
VIPR by ZIVA	Limited 1 year warranty*
SL Tyre X	Limited 1 year warranty*
ZVO Stability Balls	Limited 1 year warranty*
Plyo Boxes	Limited 1 year warranty*
ZVO PU Bumper Discs	Limited 5 year warranty*
XP Rubber Bumper Discs	Limited 1 year warranty*
ZVO Olympic Bars	Limited lifetime warranty*
XP Olympic Platforms	Limited 1 year warranty*
ST2 Racks	Limited 5 year warranty on frames and welding* Rubber & plastic parts 1 year warranty*
SL Hexagon Dumbbells	Limited 3 years on Urethane; Limited 2 year warranty on rubber*
XP Racks	Limited 3 year warranty for frame; Plastic and Rubber parts have a limited 1 year warranty*
XP Hex Dumbbells	Limited 1 year warranty*
Signature Kettlebells	Limited 2 year warranty*
ZVO Slam Balls	Limited 1 year warranty
ZVO Medicine Balls	Limited 1 year warranty, Warranty Void with Product Abuse*
ZVO Wall Balls	Limited 1 year warranty, Warranty Void with Product Abuse*
ZVO Power Core Bag	Limited 1 year warranty*
XP Modular Rigs	Limited 5 year warranty for frame; Plastic and Rubber parts have a limited 1 year warranty*
XP Accessories	Limited 1 year warranty*

GROUP X

Signature FitBench	Limited 2 year warranty on frames and welding*; Plastic and Rubber parts have a limited 1 year warranty
Signature Powerwave	Limited 2 year warranty*
VIPR by ZIVA	Limited 1 year warranty*
PRO FT Step	Limited 1 year warranty*
ZVO Studio Barbell Set	Limited 2 year warranty on PU; Limited 1 year on rubber; Frames and welding on rack 5 years; Plastic and Rubber parts have a limited 1 year warranty*
SL Yoga Mats	Limited 1 year warranty*

CUSTOMIZATION

ZVO Free Weights	Limited 5 year warranty on Urethane;
XP Rigs	Limited 5 year warranty for frame; Plastic and Rubber parts have a limited 1 year warranty

*For more information about warranty of product's parts and more detailed information, please contact ZIVA customer service at globalwarranty@zivalife.com

ZIVA

— THE WAY TO LIVE —

98 Yanping Road, Block C, 2nd Floor
Jing' an District, Shanghai 200042 CHINA

T +86 21 6246 0091 | F +86 21 3255 9860 | sales@zivalife.com
👍 facebook.com/ziva.global 📷 instagram.com/ziva.global

www.ziva.global